

## N-Channel Enhancement Mode Power MOSFET

### Features

- $V_{DS} = 20V$ ,  $I_D = 12A$   
 $R_{DS(ON)} < 6\ m\Omega$  @  $V_{GS} = 4.5V$   
 $R_{DS(ON)} < 8\ m\Omega$  @  $V_{GS} = 2.5V$

### General Features

- Advanced Trench Technology
- Provide Excellent  $R_{DS(ON)}$  and Low Gate Charge
- Lead Free and Green Available

100% UIS TESTED!  
 100%  $\Delta V_{ds}$  TESTED!



SOP-8

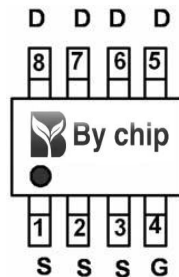

pin assignment

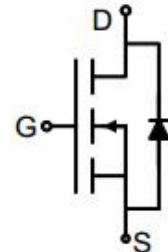

Schematic diagram

### Absolute Maximum Ratings ( $T_A = 25^\circ C$ unless otherwise noted)

Parameter	Symbol	Limit	Unit
Drain-Source Voltage	$V_{DS}$	20	V
Gate-Source Voltage	$V_{GS}$	$\pm 12$	V
Drain Current-Continuous	$I_D$	12	A
Drain Current-Continuous( $T_A = 100^\circ C$ )	$I_D(100^\circ C)$	8	A
Pulsed Drain Current	$I_{DM}$	40	A
Maximum Power Dissipation	$P_D$	2.5	W
Operating Junction and Storage Temperature Range	$T_J, T_{STG}$	-55 To 150	$^\circ C$

### Thermal Characteristic

Thermal Resistance, Junction-to-Ambient <sup>(Note 2)</sup>	$R_{\theta JA}$	50	$^\circ C/W$
---	-----------------	----	--------------

**Electrical Characteristics ( $T_A=25^{\circ}\text{C}$  unless otherwise noted)**

Parameter	Symbol	Condition	Min	Typ	Max	Unit
<b>Off Characteristics</b>						
Drain-Source Breakdown Voltage	$BV_{DSS}$	$V_{GS}=0V, I_D=250\mu A$	20	-	-	V
Zero Gate Voltage Drain Current	$I_{DSS}$	$V_{DS}=20V, V_{GS}=0V$	-	-	1	$\mu A$
Gate-Body Leakage Current	$I_{GSS}$	$V_{GS}=\pm 12V, V_{DS}=0V$	-	-	$\pm 100$	nA
<b>On Characteristics</b> (Note 3)						
Gate Threshold Voltage	$V_{GS(th)}$	$V_{DS}=V_{GS}, I_D=250\mu A$	0.5		2.0	V
Drain-Source On-State Resistance	$R_{DS(ON)}$	$V_{GS}=4.5V, I_D=6A$	-		6	m $\Omega$
		$V_{GS}=2.5V, I_D=5A$			8	m $\Omega$
Forward Transconductance	$g_{FS}$	$V_{DS}=10V, I_D=6A$	20	-	-	S
<b>Dynamic Characteristics</b> (Note 4)						
Input Capacitance	$C_{iss}$	$V_{DS}=10V, V_{GS}=0V,$ $F=1.0\text{MHz}$	-	2000	-	PF
Output Capacitance	$C_{oss}$		-	402	-	PF
Reverse Transfer Capacitance	$C_{rss}$		-	170	-	PF
<b>Switching Characteristics</b> (Note 4)						
Turn-on Delay Time	$t_{d(on)}$	$V_{DD}=10V, I_D=6A$ $V_{GS}=4.5V, R_{GEN}=1\Omega$	-	25	-	nS
Turn-on Rise Time	$t_r$		-	15	-	nS
Turn-Off Delay Time	$t_{d(off)}$		-	25	-	nS
Turn-Off Fall Time	$t_f$		-	15	-	nS
Total Gate Charge	$Q_g$	$V_{DS}=10V, I_D=6A,$ $V_{GS}=10V$	-	42	-	nC
Gate-Source Charge	$Q_{gs}$		-	10.8	-	nC
Gate-Drain Charge	$Q_{gd}$		-	9.2	-	nC
<b>Drain-Source Diode Characteristics</b>						
Diode Forward Voltage (Note 3)	$V_{SD}$	$V_{GS}=0V, I_S=6A$	-	-	1.2	V
Diode Forward Current (Note 2)	$I_S$		-	-	12	A

**Notes:**

1. Repetitive Rating: Pulse width limited by maximum junction temperature.
2. Surface Mounted on FR4 Board,  $t \leq 10$  sec.
3. Pulse Test: Pulse Width  $\leq 300\mu s$ , Duty Cycle  $\leq 2\%$ .
4. Guaranteed by design, not subject to production

### Test Circuit

#### 1) E<sub>AS</sub> Test Circuits

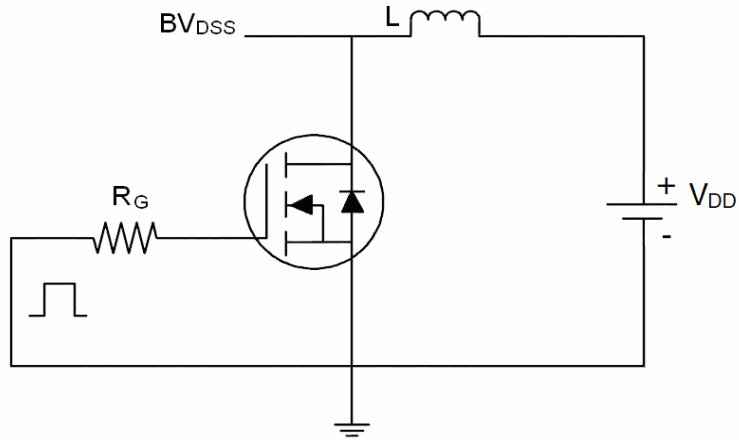

#### 2) Gate Charge Test Circuit



#### 3) Switch Time Test Circuit

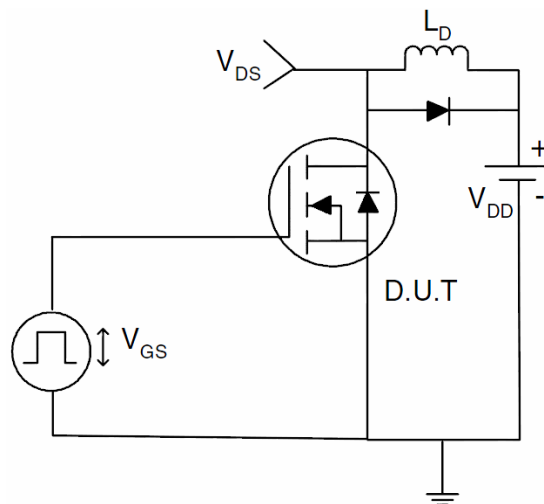

Typical Electrical and Thermal Characteristics (Curves)

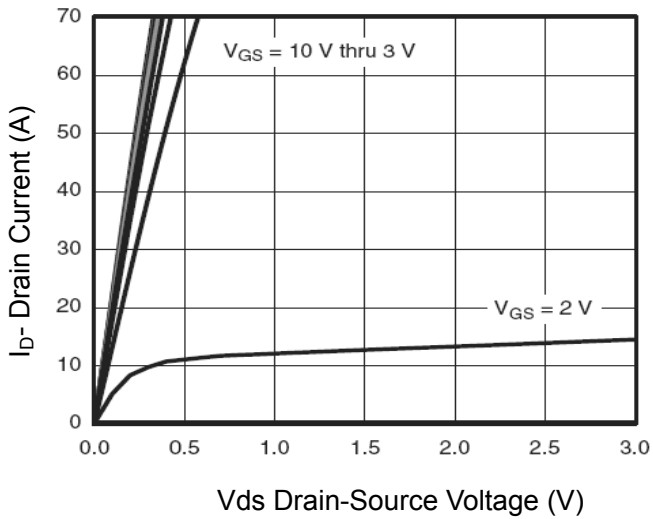

Figure 1 Output Characteristics

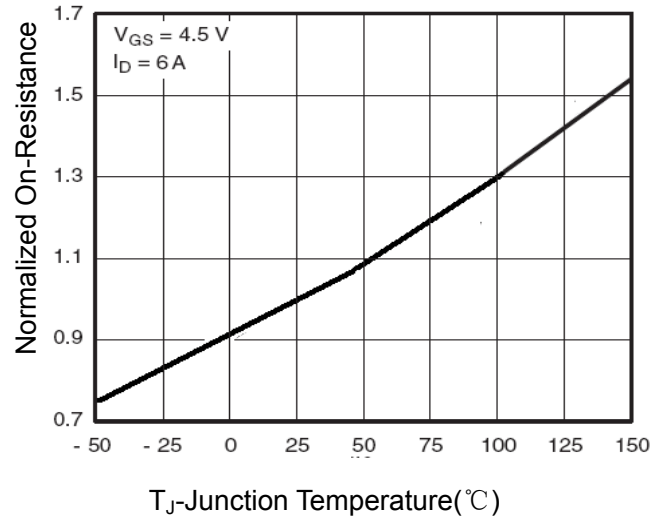

Figure 4  $R_{dson}$ -Junction Temperature

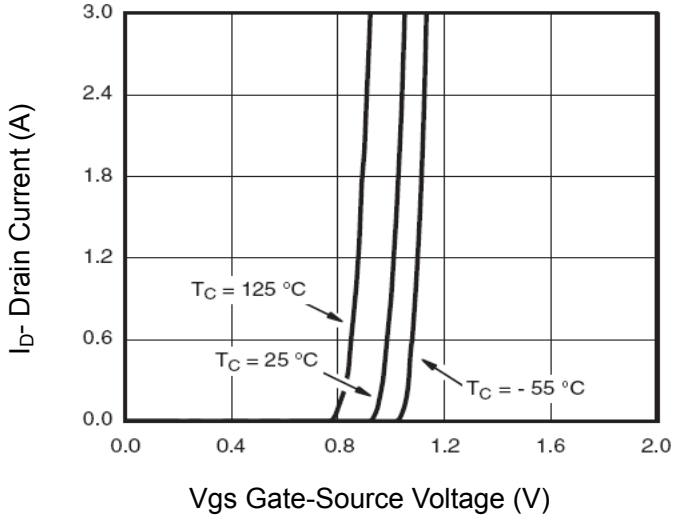

Figure 2 Transfer Characteristics

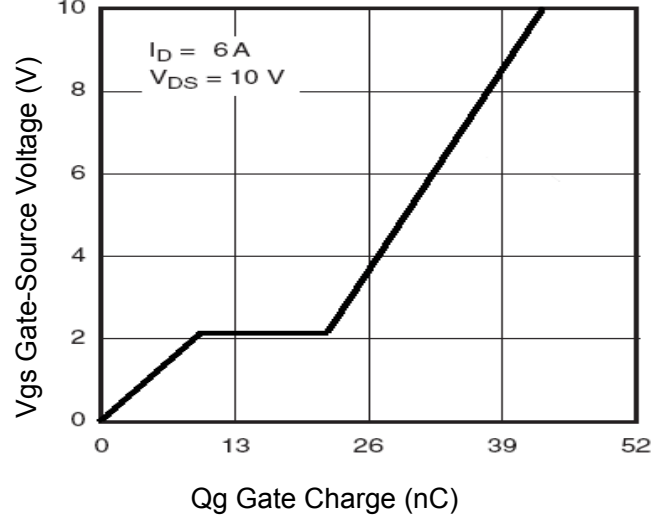

Figure 5 Gate Charge

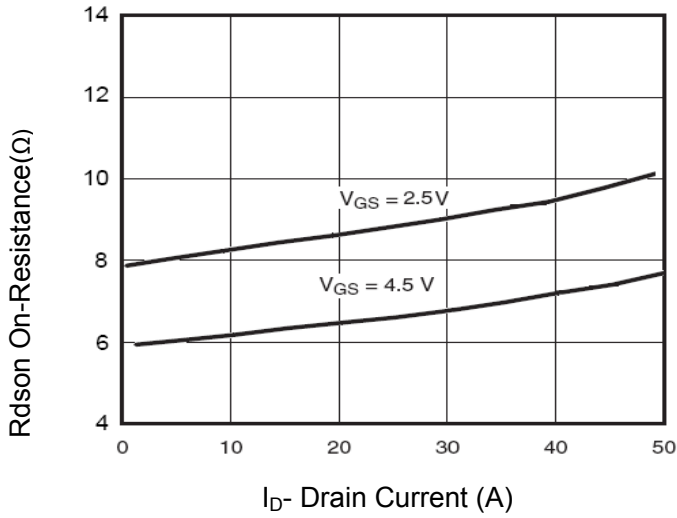

Figure 3  $R_{dson}$ - Drain Current

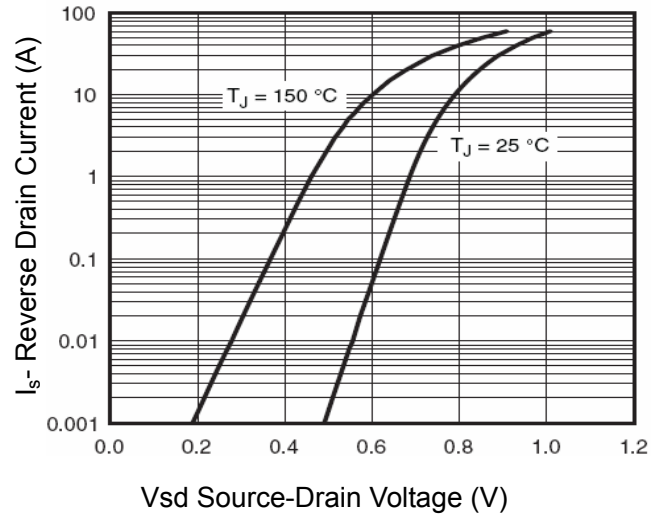

Figure 6 Source- Drain Diode Forward

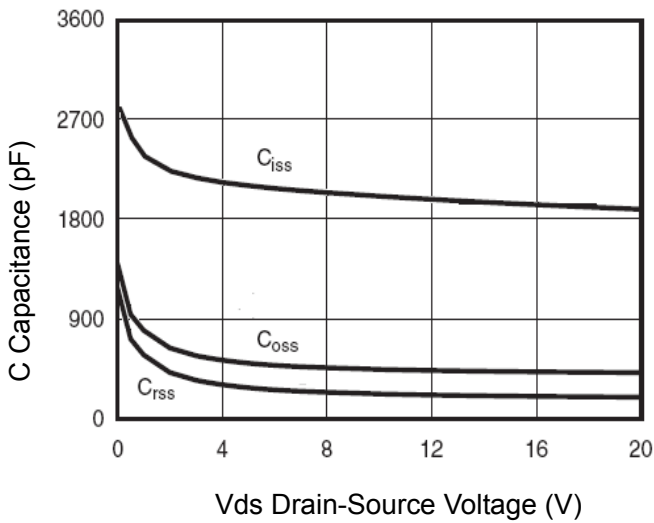

Figure 7 Capacitance vs Vds

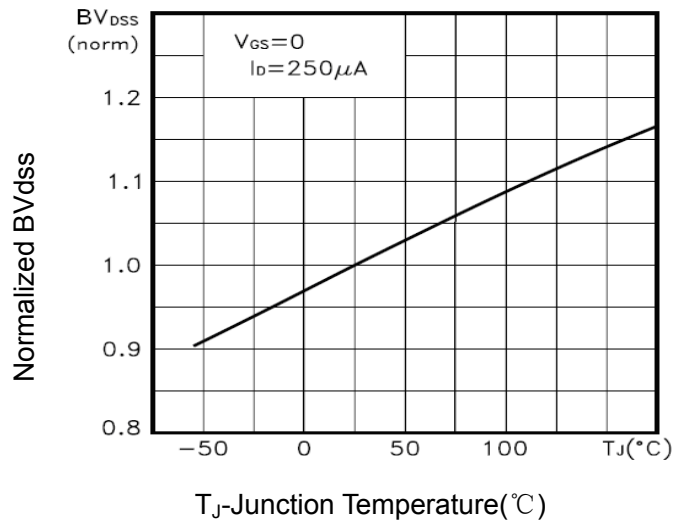

Figure 9  $BV_{DSS}$  vs Junction Temperature

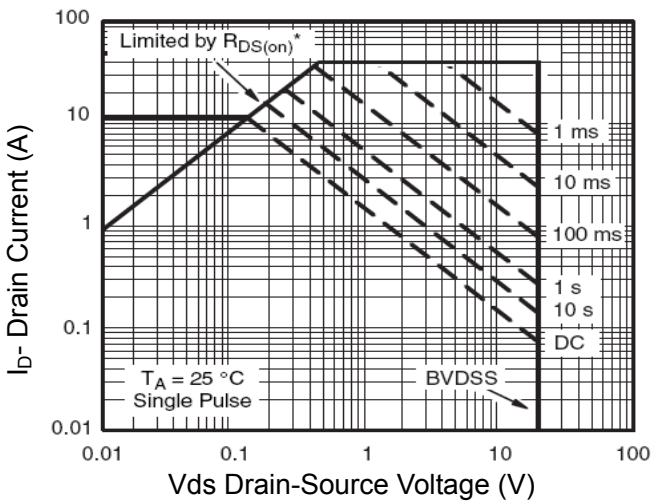

Figure 8 Safe Operation Area

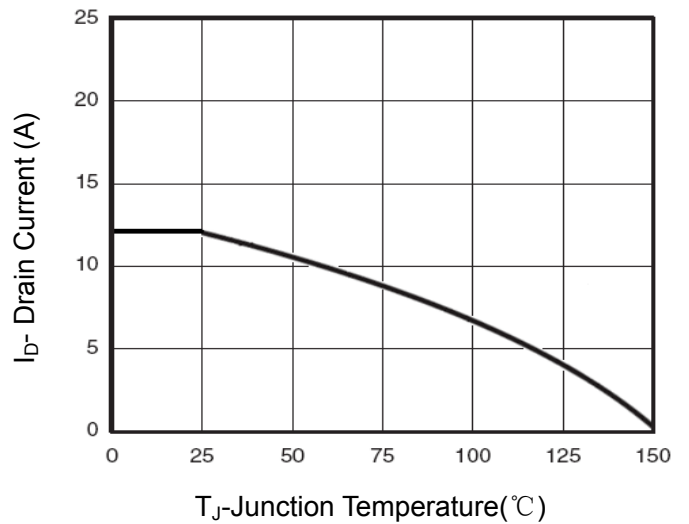

Figure 10 Current vs Junction Temperature

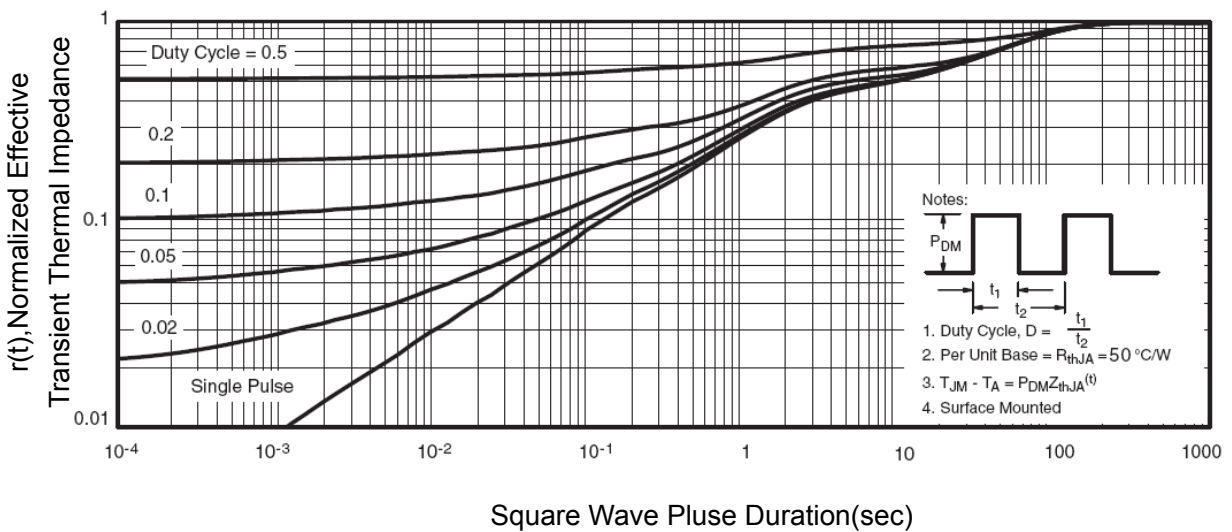

Figure 11 Normalized Maximum Transient Thermal Impedance