

## 具有折返式电流限制的 TLV741P 150mA 低压差稳压器

### 1 特性

- 输入电压范围：1.4V 至 5.5V
- 使用 1 $\mu$ F 陶瓷电容器实现稳定工作
- 折返过流保护
- 封装：
  - 5 引脚 SOT-23
  - 4 引脚 X2SON
- 超低压降：150mA 时为 230mV
- 准确度：1%
- 低  $I_Q$ ：50 $\mu$ A
- 可提供固定输出电压：1V 至 3.3V
- 高 PSRR：1kHz 时为 65dB
- 有源输出放电（仅限 P 版本）

### 2 应用

- 掌上电脑 (PDA) 和电池供电便携式设备
- MP3 播放器和其它手持产品
- 无线局域网 (WLAN) 及其他 PC 附加卡

### 3 说明

TLV741P 低压降线性稳压器 (LDO) 是一款低静态电流器件，具有出色的线路和负载瞬态性能，适用于功耗敏感型应用。此器件提供了 1% 的典型精度。

TLV741P 旨在使用小型的 1 $\mu$ F 输出电容器实现稳定工作。

TLV741P 可在器件加电和使能期间提供浪涌电流控制。TLV741P 将输入电流限制为定义的电流限值，从而防止从输入电源流出的电流过大。该功能对于电池供电型器件尤为重要。

TLV741P 采用标准 DBV (SOT-23) 和 DQN (X2SON) 封装。TLV741P 提供了有源下拉电路，用于对输出负载进行快速放电。

器件信息<sup>(1)</sup>

器件名称	封装	封装尺寸
TLV741P	SOT-23 (5)	2.90mm x 1.60mm
	X2SON (4)	1.00mm x 1.00mm

(1) 如需了解所有可用封装，请参阅数据表末尾的封装选项附录。

典型应用电路

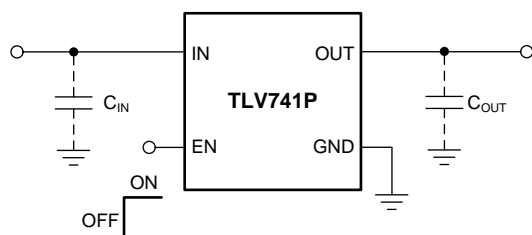

压降电压与输出电流间的关系

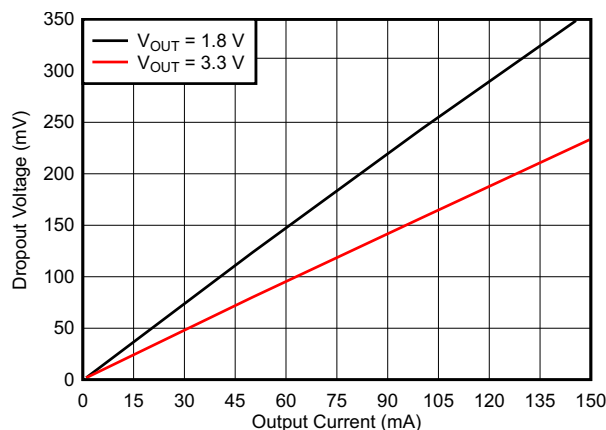

## 目录

<b>1</b>	特性 .....	<b>1</b>	<b>8</b>	<b>Application and Implementation</b> .....	<b>14</b>
<b>2</b>	应用 .....	<b>1</b>	8.1	Application Information.....	14
<b>3</b>	说明 .....	<b>1</b>	8.2	Typical Application .....	15
<b>4</b>	修订历史记录 .....	<b>2</b>	8.3	What to Do and What Not to Do .....	16
<b>5</b>	<b>Pin Configuration and Functions</b> .....	<b>3</b>	<b>9</b>	<b>Power Supply Recommendations</b> .....	<b>17</b>
<b>6</b>	<b>Specifications</b> .....	<b>4</b>	<b>10</b>	<b>Layout</b> .....	<b>17</b>
6.1	Absolute Maximum Ratings .....	4	10.1	Layout Guidelines .....	17
6.2	ESD Ratings.....	4	10.2	Layout Examples.....	17
6.3	Recommended Operating Conditions .....	4	10.3	Power Dissipation .....	18
6.4	Thermal Information .....	4	<b>11</b>	<b>器件和文档支持</b> .....	<b>19</b>
6.5	Electrical Characteristics.....	5	11.1	文档支持 .....	19
6.6	Typical Characteristics .....	7	11.2	接收文档更新通知 .....	19
<b>7</b>	<b>Detailed Description</b> .....	<b>11</b>	11.3	社区资源 .....	19
7.1	Overview .....	11	11.4	商标 .....	19
7.2	Functional Block Diagram .....	11	11.5	静电放电警告 .....	19
7.3	Feature Description.....	12	11.6	术语表 .....	19
7.4	Device Functional Modes.....	13	<b>12</b>	<b>机械、封装和可订购信息</b> .....	<b>19</b>

## 4 修订历史记录

Changes from Original (July 2017) to Revision A	Page
• 已添加 在数据表中添加 DQN (X2SON) 封装 .....	1

## 5 Pin Configuration and Functions

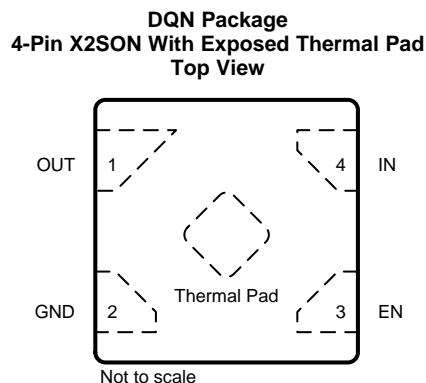
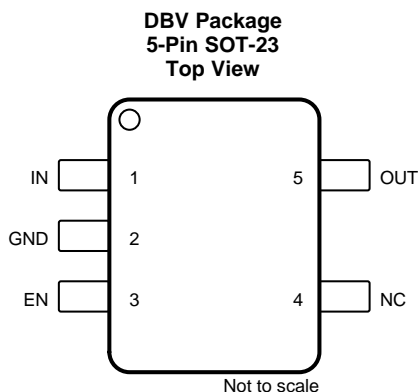

### Pin Functions

NAME	PIN		I/O	DESCRIPTION
	NO.			
	SOT-23	X2SON		
EN	3	3	I	Enable pin. Driving EN over 0.9 V turns on the regulator. Driving EN below 0.4 V puts the regulator into shutdown mode.
GND	2	2	—	Ground pin
IN	1	4	I	Input pin. Use a small capacitor from this pin to ground. See the <a href="#">Input and Output Capacitor Considerations</a> section for more details.
NC	4	—	—	No internal connection
OUT	5	1	O	Regulated output voltage pin. For best transient response, use a small 1- $\mu$ F ceramic capacitor from this pin to ground. See the <a href="#">Input and Output Capacitor Considerations</a> section for more details.
Thermal pad	—	—	—	The thermal pad is electrically connected to the GND node. Connect the thermal pad to the ground plane for improved thermal performance.

## 6 Specifications

### 6.1 Absolute Maximum Ratings

over operating junction temperature range (unless otherwise noted). All voltages are with respect to GND. <sup>(1)</sup>

		MIN	MAX	UNIT
Voltage	Input, $V_{IN}$	-0.3	6	V
	Enable, $V_{EN}$	-0.3	$V_{IN} + 0.3$	
	Output, $V_{OUT}$	-0.3	3.6	
Current	Maximum output, $I_{OUT(max)}$	Internally limited		
Output short-circuit duration		Indefinite		
Total power dissipation	Continuous, $P_{D(tot)}$	See <a href="#">Thermal Information</a>		
Temperature	Junction, $T_J$	-55	125	°C
	Storage, $T_{stg}$	-55	150	

- (1) Stresses beyond those listed under *Absolute Maximum Ratings* may cause permanent damage to the device. These are stress ratings only, which do not imply functional operation of the device at these or any other conditions beyond those indicated under *Recommended Operating Conditions*. Exposure to absolute-maximum-rated conditions for extended periods may affect device reliability.

### 6.2 ESD Ratings

			VALUE	UNIT
$V_{(ESD)}$	Electrostatic discharge	Human body model (HBM), per ANSI/ESDA/JEDEC JS-001, all pins <sup>(1)</sup>	±2000	V
		Charged device model (CDM), per JEDEC specification JESD22-C101, all pins <sup>(2)</sup>	±500	

- (1) JEDEC document JEP155 states that 500-V HBM allows safe manufacturing with a standard ESD control process.  
 (2) JEDEC document JEP157 states that 250-V CDM allows safe manufacturing with a standard ESD control process.

### 6.3 Recommended Operating Conditions

over operating junction temperature range (unless otherwise noted)

		MIN	NOM	MAX	UNIT
$V_{IN}$	Input voltage	1.4		5.5	V
$V_{EN}$	Enable range	0		$V_{IN}$	V
$I_{OUT}$	Output current	0		150	mA
$C_{IN}$	Input capacitor	0	1		µF
$C_{OUT}$	Output capacitor	1		100	µF
$T_J$	Operating junction temperature	-40		125	°C

### 6.4 Thermal Information

THERMAL METRIC <sup>(1)</sup>		TLV741P		UNIT
		DQN (X2SON)	DBV (SOT-23)	
		4 PINS	5 PINS	
$R_{\theta JA}$	Junction-to-ambient thermal resistance	228.5	249	°C/W
$R_{\theta JC(top)}$	Junction-to-case (top) thermal resistance	210.4	172.7	°C/W
$R_{\theta JB}$	Junction-to-board thermal resistance	174.7	76.7	°C/W
$\Psi_{JT}$	Junction-to-top characterization parameter	21.2	49.7	°C/W
$\Psi_{JB}$	Junction-to-board characterization parameter	174.5	75.8	°C/W
$R_{\theta JC(bot)}$	Junction-to-case (bottom) thermal resistance	140.6	N/A	°C/W

- (1) For more information about traditional and new thermal metrics, see the [Semiconductor and IC Package Thermal Metrics application report](#)

## 6.5 Electrical Characteristics

over operating temperature range  $T_J = -40^\circ\text{C}$  to  $+125^\circ\text{C}$ ,  $V_{IN(nom)} = V_{OUT(nom)} + 0.5\text{ V}$  or  $V_{IN(nom)} = 2\text{ V}$  (whichever is greater),  $I_{OUT} = 1\text{ mA}$ ,  $V_{EN} = V_{IN}$ , and  $C_{OUT} = 1\text{ }\mu\text{F}$  (unless otherwise noted). Typical values are at  $T_J = 25^\circ\text{C}$ .

PARAMETER		TEST CONDITIONS		MIN	TYP	MAX	UNIT	
$V_{OUT}$	Output voltage range			1		3.3	V	
	DC output accuracy	$V_{OUT} \geq 1.8\text{ V}$ $T_J = 25^\circ\text{C}$		-1%		1%		
		$V_{OUT} < 1.8\text{ V}$ $T_J = 25^\circ\text{C}$		-20		20	mV	
		$V_{OUT} \geq 1.2\text{ V}$ $-40^\circ\text{C} \leq T_J \leq 125^\circ\text{C}$		-1.5%		1.5%		
		$V_{OUT} < 1.2\text{ V}$ $-40^\circ\text{C} \leq T_J \leq 125^\circ\text{C}$		-50		50	mV	
$\Delta V_{OUT(\Delta V_{IN})}$	Line regulation	Maximum $\{V_{OUT(nom)} + 0.5\text{ V}$ $V_{IN} = 2\text{ V}\} \leq V_{IN} \leq 5.5\text{ V}$			1	5	mV	
$\Delta V_{OUT(\Delta I_{OUT})}$	Load regulation	$0\text{ mA} \leq I_{OUT} \leq 150\text{ mA}$			10	30	mV	
$V_{DO}$	Dropout voltage	$V_{OUT} = 0.98 \times V_{OUT(nom)}$ $T_J = -40^\circ\text{C}$ to $85^\circ\text{C}$	$1\text{ V} \leq V_{OUT} < 1.8\text{ V}$ $I_{OUT} = 150\text{ mA}$		600	900	mV	
			$V_{OUT} = 1.1\text{ V}$ $I_{OUT} = 100\text{ mA}$		470	600		
			$1.8\text{ V} \leq V_{OUT} < 2.1\text{ V}$ $I_{OUT} = 30\text{ mA}$		70			
			$1.8\text{ V} \leq V_{OUT} < 2.1\text{ V}$ $I_{OUT} = 150\text{ mA}$		350	575		
			$2.1\text{ V} \leq V_{OUT} < 2.5\text{ V}$ $I_{OUT} = 30\text{ mA}$		90			
			$2.1\text{ V} \leq V_{OUT} < 2.5\text{ V}$ $I_{OUT} = 150\text{ mA}$		290	481		
			$2.5\text{ V} \leq V_{OUT} < 3\text{ V}$ $I_{OUT} = 30\text{ mA}$		50			
			$2.5\text{ V} \leq V_{OUT} < 3\text{ V}$ $I_{OUT} = 150\text{ mA}$		246	445		
		$3\text{ V} \leq V_{OUT} < 3.6\text{ V}$ $I_{OUT} = 30\text{ mA}$		46				
		$3\text{ V} \leq V_{OUT} < 3.6\text{ V}$ $I_{OUT} = 150\text{ mA}$		230	420			
		$V_{OUT} = 0.98 \times V_{OUT(nom)}$ $T_J = -40^\circ\text{C}$ to $125^\circ\text{C}$	$1\text{ V} \leq V_{OUT} < 1.8\text{ V}$ $I_{OUT} = 150\text{ mA}$		600	1020		
			$V_{OUT} = 1.1\text{ V}$ $I_{OUT} = 100\text{ mA}$		470	720		
			$1.8\text{ V} \leq V_{OUT} < 2.1\text{ V}$ $I_{OUT} = 150\text{ mA}$		350	695		
			$2.1\text{ V} \leq V_{OUT} < 2.5\text{ V}$ $I_{OUT} = 150\text{ mA}$		290	601		
			$2.5\text{ V} \leq V_{OUT} < 3\text{ V}$ $I_{OUT} = 150\text{ mA}$		246	565		
			$3\text{ V} \leq V_{OUT} < 3.6\text{ V}$ $I_{OUT} = 150\text{ mA}$		230	540		
$I_{GND}$	Ground pin current		$I_{OUT} = 0\text{ mA}$			50	75	$\mu\text{A}$
$I_{SHUTDOWN}$	Shutdown current		$V_{EN} \leq 0.4\text{ V}$ , $2\text{ V} \leq V_{IN} \leq 5.5\text{ V}$ $T_J = 25^\circ\text{C}$			0.1	1	$\mu\text{A}$
PSRR	Power-supply rejection ratio	$V_{IN} = 3.3\text{ V}$ $V_{OUT} = 2.8\text{ V}$ $I_{OUT} = 30\text{ mA}$	$f = 100\text{ Hz}$		70	dB		
			$f = 10\text{ kHz}$		55			
			$f = 1\text{ MHz}$		55			
$V_n$	Output noise voltage	BW = 100 Hz to 100 kHz $V_{IN} = 2.3\text{ V}$ $V_{OUT} = 1.8\text{ V}$ $I_{OUT} = 10\text{ mA}$			73	$\mu\text{V}_{RMS}$		
$t_{STR}$	Start-up time <sup>(1)</sup>	$C_{OUT} = 1\text{ }\mu\text{F}$ $I_{OUT} = 150\text{ mA}$			100	$\mu\text{s}$		

(1) Start-up time is the time from EN assertion to  $(0.98 \times V_{OUT(nom)})$ .

**Electrical Characteristics (continued)**

over operating temperature range  $T_J = -40^{\circ}\text{C}$  to  $+125^{\circ}\text{C}$ ,  $V_{\text{IN}(\text{nom})} = V_{\text{OUT}(\text{nom})} + 0.5\text{ V}$  or  $V_{\text{IN}(\text{nom})} = 2\text{ V}$  (whichever is greater),  $I_{\text{OUT}} = 1\text{ mA}$ ,  $V_{\text{EN}} = V_{\text{IN}}$ , and  $C_{\text{OUT}} = 1\text{ }\mu\text{F}$  (unless otherwise noted). Typical values are at  $T_J = 25^{\circ}\text{C}$ .

PARAMETER		TEST CONDITIONS	MIN	TYP	MAX	UNIT
$V_{\text{HI}}$	Enable high (enabled)		0.9		$V_{\text{IN}}$	V
$V_{\text{LO}}$	Enable low (disabled)		0		0.4	V
$I_{\text{EN}}$	EN pin current	EN = 5.5 V		0.01		$\mu\text{A}$
$R_{\text{PULLDOWN}}$	Pulldown resistor	$V_{\text{IN}} = 4\text{ V}$		120		$\Omega$
$I_{\text{LIM}}$	Output current limit	$V_{\text{IN}} = 3.8\text{ V}$ $V_{\text{OUT}} = 3.3\text{ V}$ $T_J = -40\text{ to }85^{\circ}\text{C}$	180			mA
		$V_{\text{IN}} = 2.25\text{ V}$ $V_{\text{OUT}} = 1.8\text{ V}$ $T_J = -40\text{ to }85^{\circ}\text{C}$	180			
		$V_{\text{IN}} = 2\text{ V}$ $V_{\text{OUT}} = 1.2\text{ V}$ $T_J = -40\text{ to }85^{\circ}\text{C}$	180			
$I_{\text{SC}}$	Short-circuit current	$V_{\text{OUT}} = 0\text{ V}$		40		mA
$T_{\text{SD}}$	Thermal shutdown	Shutdown, temperature increasing		158		$^{\circ}\text{C}$
		Reset, temperature decreasing		140		

### 6.6 Typical Characteristics

over operating temperature range  $T_J = -40^{\circ}\text{C}$  to  $+125^{\circ}\text{C}$ ,  $V_{IN} = V_{OUT(nom)} + 0.5\text{ V}$  or  $2\text{ V}$  (whichever is greater),  $I_{OUT} = 10\text{ mA}$ ,  $V_{EN} = V_{IN}$ ,  $C_{OUT} = 1\text{ }\mu\text{F}$ , and  $V_{OUT(nom)} = 1.8\text{ V}$  (unless otherwise noted). Typical values are at  $T_J = 25^{\circ}\text{C}$ .



图 1. 1.8-V Line Regulation vs  $V_{IN}$  and Temperature



图 2. 1.8-V Load Regulation vs  $I_{OUT}$  and Temperature

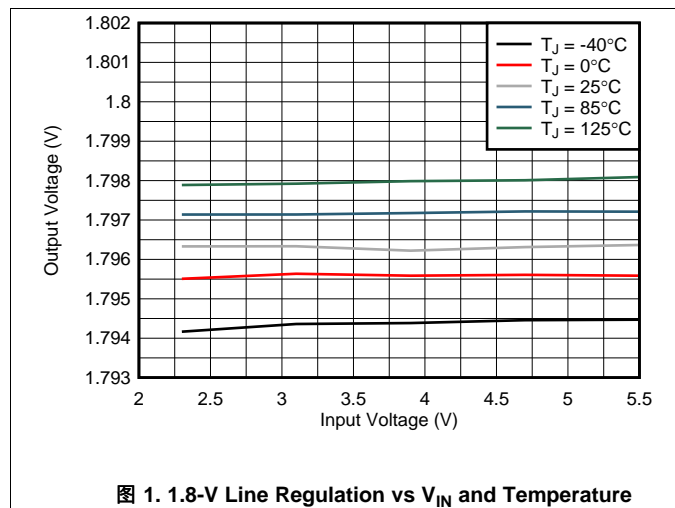

图 3. 1.8-V Output Voltage Over Temperature

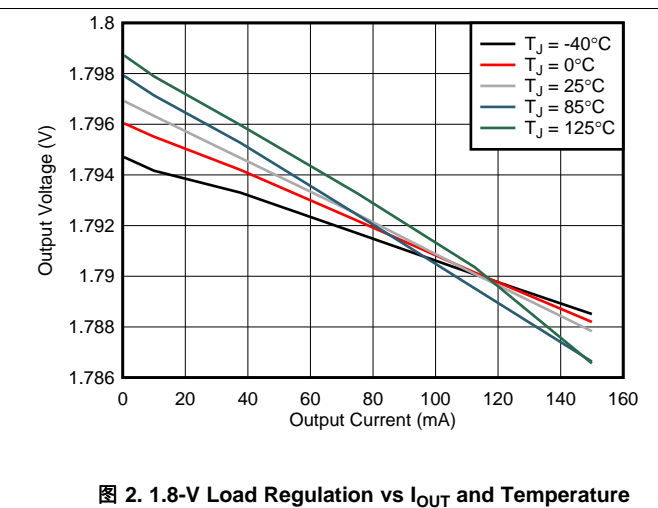

图 4. 1.8-V Dropout Voltage vs  $I_{OUT}$  and Temperature

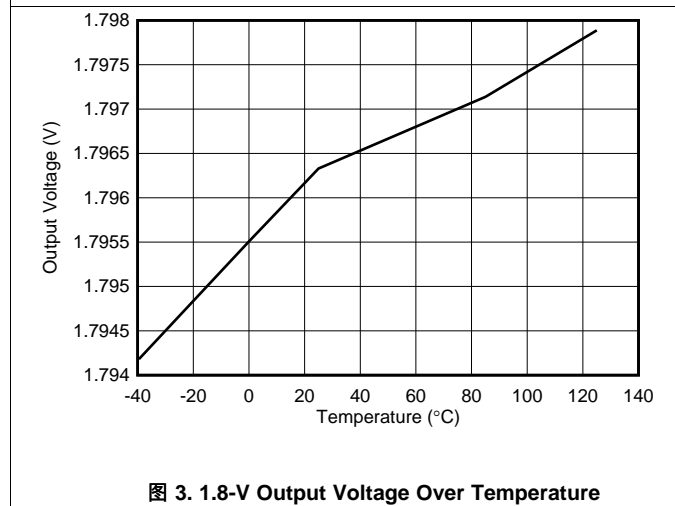

图 5. 3.3-V Dropout Voltage vs  $I_{OUT}$  and Temperature

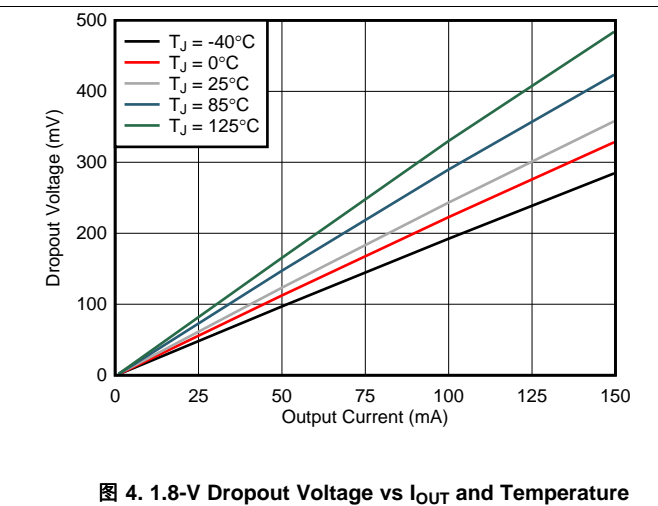

图 6. Ground Pin Current vs  $V_{IN}$  and Temperature

Typical Characteristics (接下页)

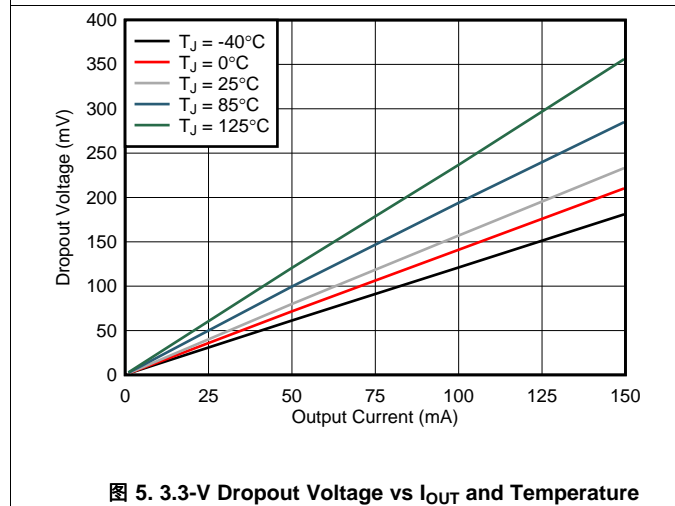
over operating temperature range  $T_J = -40^{\circ}\text{C}$  to  $+125^{\circ}\text{C}$ ,  $V_{IN} = V_{OUT(nom)} + 0.5\text{ V}$  or  $2\text{ V}$  (whichever is greater),  $I_{OUT} = 10\text{ mA}$ ,  $V_{EN} = V_{IN}$ ,  $C_{OUT} = 1\text{ }\mu\text{F}$ , and  $V_{OUT(nom)} = 1.8\text{ V}$  (unless otherwise noted). Typical values are at  $T_J = 25^{\circ}\text{C}$ .

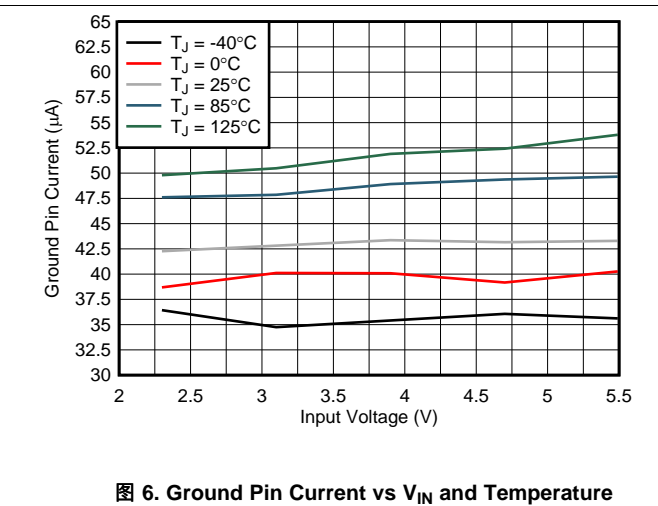

图 7. Ground Pin Current vs  $I_{OUT}$  and Temperature



图 8. Shutdown Current vs  $V_{IN}$  and Temperature

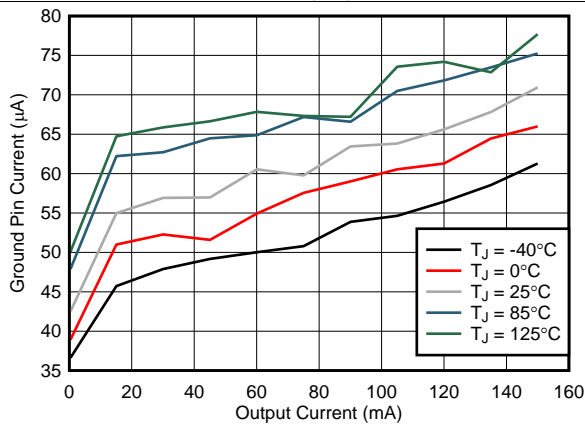

图 9. Power-Supply Rejection Ratio Over  $C_{OUT}$

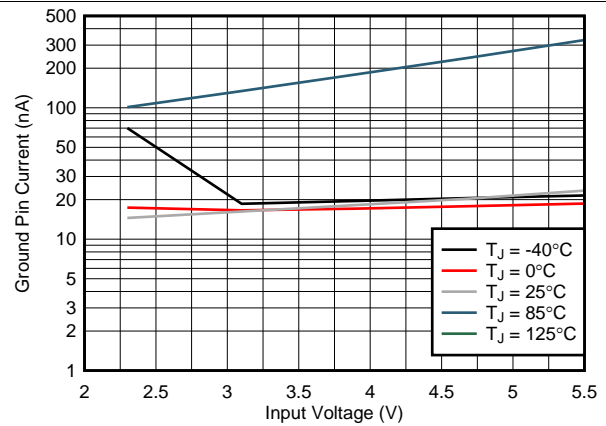

图 10. Power-Supply Rejection Ratio Over  $I_{OUT}$

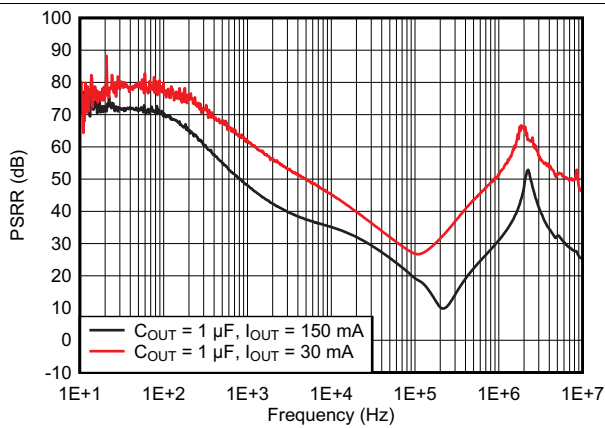

图 11. Output Spectral Noise Density

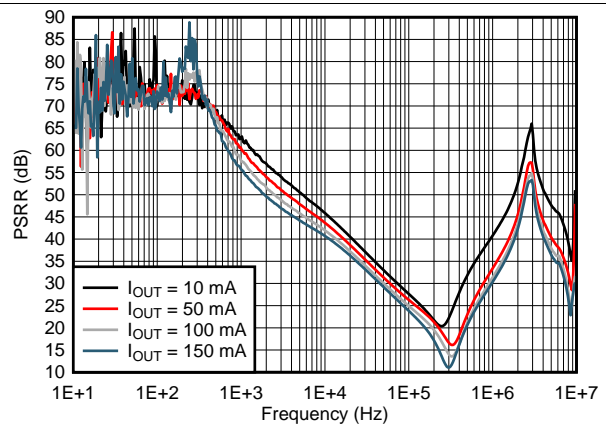

图 12. Line Transient

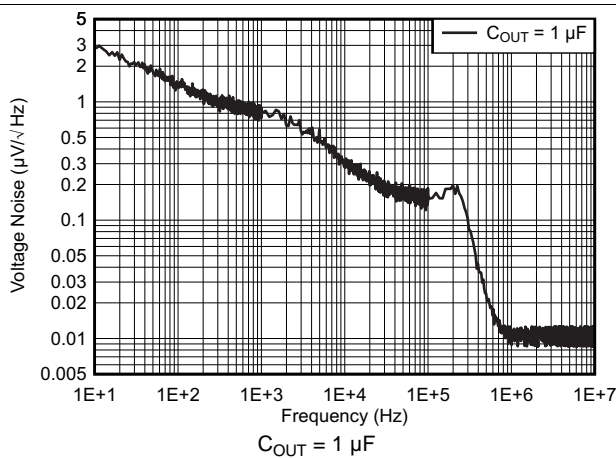

Typical Characteristics (接下页)

over operating temperature range  $T_J = -40^{\circ}\text{C}$  to  $+125^{\circ}\text{C}$ ,  $V_{IN} = V_{OUT(nom)} + 0.5\text{ V}$  or  $2\text{ V}$  (whichever is greater),  $I_{OUT} = 10\text{ mA}$ ,  $V_{EN} = V_{IN}$ ,  $C_{OUT} = 1\text{ }\mu\text{F}$ , and  $V_{OUT(nom)} = 1.8\text{ V}$  (unless otherwise noted). Typical values are at  $T_J = 25^{\circ}\text{C}$ .

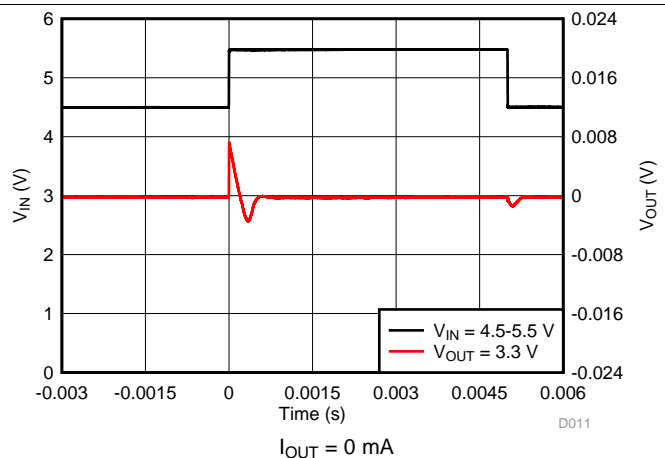
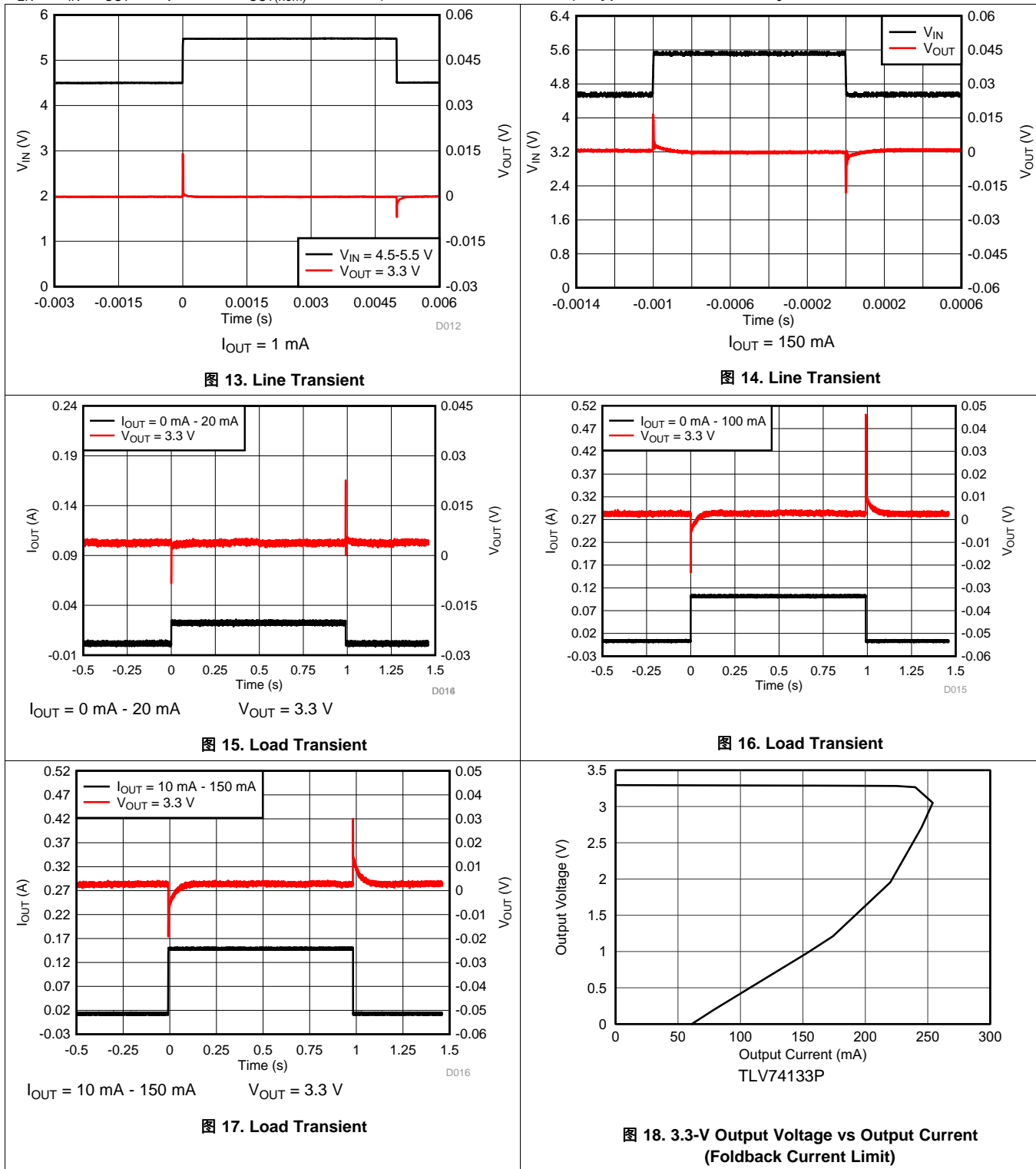

Typical Characteristics (接下页)

over operating temperature range  $T_J = -40^{\circ}\text{C}$  to  $+125^{\circ}\text{C}$ ,  $V_{IN} = V_{OUT(nom)} + 0.5\text{ V}$  or  $2\text{ V}$  (whichever is greater),  $I_{OUT} = 10\text{ mA}$ ,  $V_{EN} = V_{IN}$ ,  $C_{OUT} = 1\text{ }\mu\text{F}$ , and  $V_{OUT(nom)} = 1.8\text{ V}$  (unless otherwise noted). Typical values are at  $T_J = 25^{\circ}\text{C}$ .



图 19. 1.8-V Output Voltage vs Output Current (Foldback Current Limit)



图 20.  $V_{IN}$  Power-Up and Power-Down

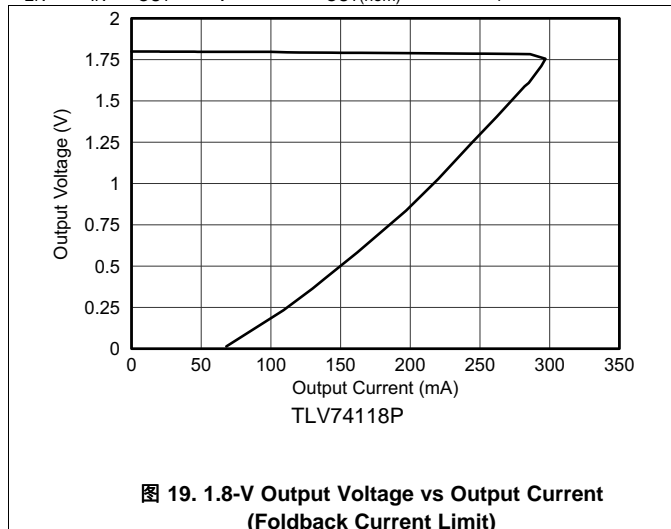

图 21. Start-Up With EN

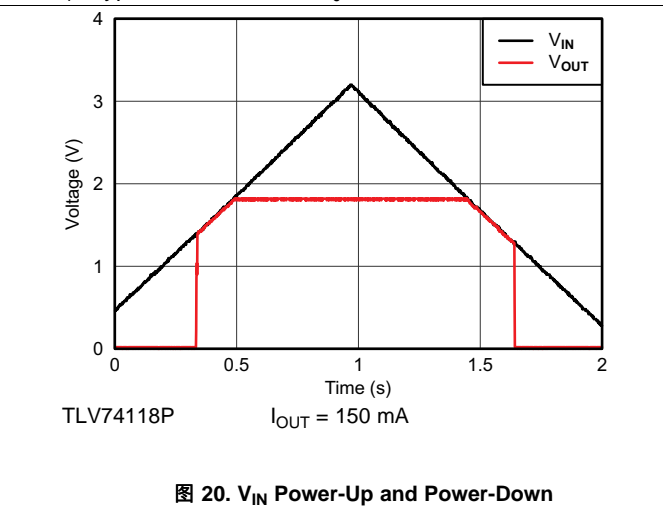

图 22. Shutdown Response With Enable

## 7 Detailed Description

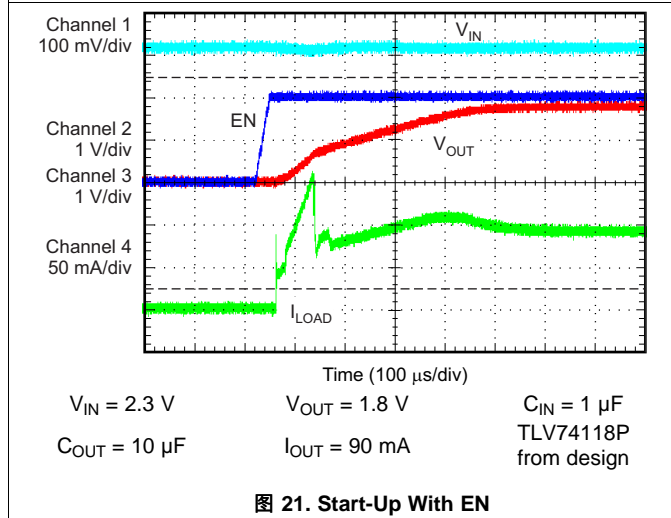
### 7.1 Overview

The TLV741P belongs to a new family of next-generation value low-dropout (LDO) regulators. The TLV741P consumes low quiescent current and delivers excellent line and load transient performance. These characteristics, combined with low noise, very good PSRR with little ( $V_{IN} - V_{OUT}$ ) headroom makes the device suitable for RF portable applications.

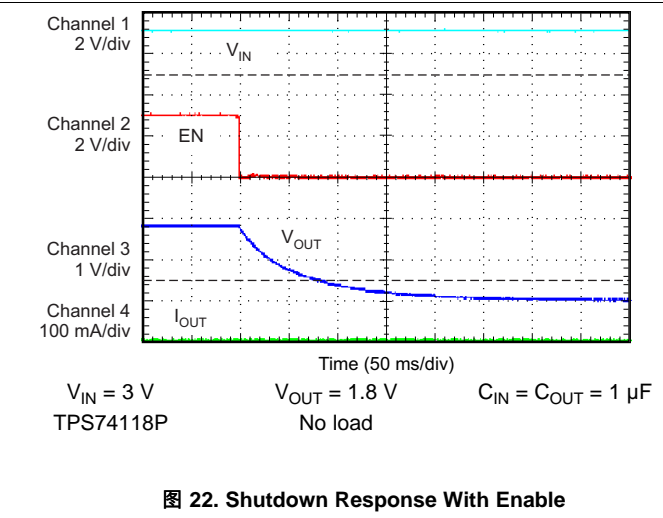
This regulator offers current limit and thermal protection. Device operating junction temperature is  $-40^{\circ}\text{C}$  to  $+125^{\circ}\text{C}$ .

### 7.2 Functional Block Diagram

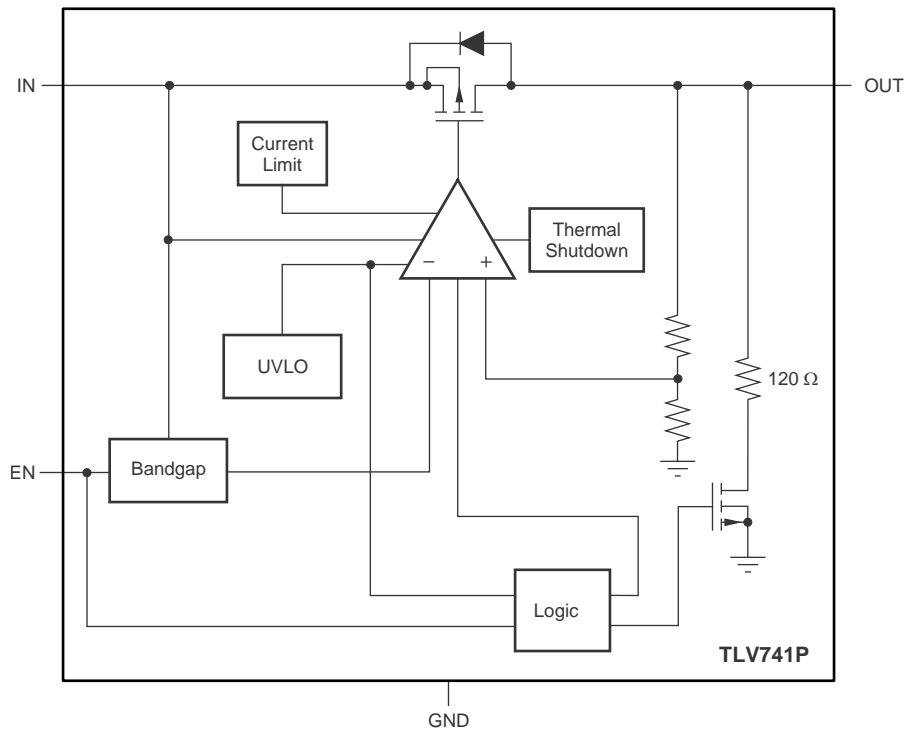

## 7.3 Feature Description

### 7.3.1 Undervoltage Lockout (UVLO)

The TLV741P uses a UVLO circuit that disables the output until the input voltage is greater than the rising UVLO voltage. The circuit makes sure that the device does not exhibit any unpredictable behavior when the supply voltage is lower than the operational range of the internal circuitry,  $V_{IN(min)}$ . During UVLO disable, the output of the TLV741P version is connected to ground with a 120- $\Omega$  pulldown resistor.

### 7.3.2 Shutdown

The enable pin (EN) is active high. Enable the device by forcing the EN pin to exceed  $V_{EN(high)}$  (0.9 V, minimum). Turn off the device by forcing the EN pin to drop below 0.4 V. If shutdown capability is not required, connect EN to IN.

The TLV741P has an internal pulldown MOSFET that connects a 120- $\Omega$  resistor to ground when the device is disabled. The discharge time after disabling depends on the output capacitance ( $C_{OUT}$ ) and the load resistance ( $R_L$ ) in parallel with the 120- $\Omega$  pulldown resistor. The time constant is calculated in [公式 1](#).

$$\tau = \frac{120 \cdot R_L}{120 + R_L} \cdot C_{OUT} \quad (1)$$

### 7.3.3 Foldback Current Limit

The TLV741P has an internal foldback current limit that helps protect the regulator during fault conditions. The current supplied by the device is gradually reduced while the output voltage decreases. When the output shorts, the LDO supplies a typical current of 40 mA. Output voltage is not regulated when the device is in current limit, and is calculated by [公式 2](#):

$$V_{OUT} = I_{LIMIT} \times R_{LOAD} \quad (2)$$

The PMOS pass transistor dissipates  $[(V_{IN} - V_{OUT}) \times I_{LIMIT}]$  until thermal shutdown is triggered and the device turns off. The internal thermal shutdown circuit turns on the device during cool down. If the fault condition continues, the device cycles between current limit and thermal shutdown. See [Thermal Protection](#) for more details.

The TLV741P PMOS pass element has a built-in body diode that conducts current when the voltage at OUT exceeds the voltage at IN. This current is not limited, so if extended reverse voltage operation is anticipated, TI recommends externally limiting the rated output current to 5%.

### 7.3.4 Thermal Protection

Thermal protection disables the output when the junction temperature rises to approximately 158°C, allowing the device to cool. When the junction temperature cools to approximately 140°C, the output circuitry is again enabled. Depending on power dissipation, thermal resistance, and ambient temperature, the thermal protection circuit may cycle on and off. This cycling limits regulator dissipation, which protects the device from damage as a result of overheating.

Any tendency to activate the thermal protection circuit indicates excessive power dissipation or an inadequate heat sink. For reliable operation, junction temperature must be limited to 125°C maximum. To estimate the margin of safety in a complete design (including heat sink), increase the ambient temperature until the thermal protection is triggered; use worst-case loads and signal conditions.

The TLV741P internal protection circuitry is designed to protect against overload conditions. This circuitry is not intended to replace proper heat sinking. Continuously running the TLV741P into thermal shutdown degrades device reliability.

## 7.4 Device Functional Modes

### 7.4.1 Normal Operation

The device regulates to the nominal output voltage under the following conditions:

- The input voltage is at least as high as  $V_{IN(min)}$ .
- The input voltage is greater than the nominal output voltage added to the dropout voltage.
- The enable voltage has previously exceeded the enable rising threshold voltage and has not decreased below the enable falling threshold.
- The output current is less than the current limit.
- The device junction temperature is less than the maximum specified junction temperature.

### 7.4.2 Dropout Operation

If the input voltage is lower than the nominal output voltage plus the specified dropout voltage, but all other conditions are met for normal operation, the device operates in dropout mode. In this mode of operation, the output voltage is the same as the input voltage minus the dropout voltage. The transient performance of the device is significantly degraded because the pass device is in the linear region and no longer controls the current through the LDO. Line or load transients in dropout can result in large output voltage deviations.

### 7.4.3 Disabled

The device is disabled under the following conditions:

- The enable voltage is less than the enable falling threshold voltage or has not yet exceeded the enable rising threshold.
- The device junction temperature is greater than the thermal shutdown temperature.

表 1 lists conditions that result in different operating modes.

**表 1. Device Functional Mode Comparison**

OPERATING MODE	PARAMETER			
	$V_{IN}$	$V_{EN}$	$I_{OUT}$	$T_J$
Normal mode	$V_{IN} > V_{OUT(nom)} + V_{DO}$ and $V_{IN} > V_{IN(min)}$	$V_{EN} > V_{EN(high)}$	$I_{OUT} < I_{LIM}$	$T_J < 125^{\circ}C$
Dropout mode	$V_{IN(min)} < V_{IN} < V_{OUT(nom)} + V_{DO}$	$V_{EN} > V_{EN(high)}$	—	$T_J < 125^{\circ}C$
Disabled mode (any true condition disables the device)	—	$V_{EN} < V_{EN(low)}$	—	$T_J > 158^{\circ}C$

## 8 Application and Implementation

---

### 注

Information in the following applications sections is not part of the TI component specification, and TI does not warrant its accuracy or completeness. TI's customers are responsible for determining suitability of components for their purposes. Customers should validate and test their design implementation to confirm system functionality.

---

### 8.1 Application Information

#### 8.1.1 Input and Output Capacitor Considerations

The TLV741P uses an advanced internal control loop to obtain stable operation by using an input or output capacitor. An output capacitance of 1  $\mu\text{F}$  or larger generally provides good dynamic response. TI recommends using X5R- and X7R-type ceramic capacitors because these capacitors have minimal variation in value and equivalent series resistance (ESR) over temperature.

Although an input capacitor is not required for stability, it is good analog design practice to connect a 0.1- $\mu\text{F}$  to 1- $\mu\text{F}$  capacitor from IN to GND. This capacitor counteracts reactive input sources and improves transient response, input ripple, and PSRR. TI recommends using an input capacitor if the source impedance is more than 0.5  $\Omega$ . A higher-value capacitor may be necessary if large, fast, rise-time load transients are anticipated or if the device is located several inches from the input power source.

#### 8.1.2 Dropout Voltage

The TLV741P uses a PMOS pass transistor to achieve low dropout. When  $(V_{\text{IN}} - V_{\text{OUT}})$  is less than the dropout voltage ( $V_{\text{DO}}$ ), the PMOS pass device is in the linear region of operation and the input-to-output resistance is the  $R_{\text{DS(on)}}$  of the PMOS pass element.  $V_{\text{DO}}$  scales approximately with output current because the PMOS device behaves like a resistor in dropout. As with any linear regulator, PSRR and transient response are degraded as  $(V_{\text{IN}} - V_{\text{OUT}})$  approaches dropout.

#### 8.1.3 Transient Response

As with any regulator, increasing the size of the output capacitor reduces over- and undershoot magnitude but increases the duration of the transient response.

## 8.2 Typical Application

Several versions of the TLV741P are suitable for powering the [MSP430 microcontroller](#).

[图 23](#) shows a diagram of the TLV741P powering an MSP430 microcontroller. [表 2](#) lists potential applications of some voltage versions.

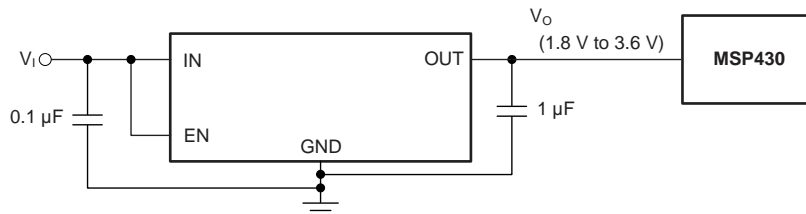

**图 23. TLV741P Powering a Microcontroller**

**表 2. Typical MSP430 Applications**

DEVICE	V <sub>OUT</sub> (TYPICAL)	APPLICATION
TLV741P18P	1.8 V	Allows for lowest power consumption with many MSP430s
TLV741P25P	2.5 V	2.2-V supply required by many MSP430s for flash programming and erasing

### 8.2.1 Design Requirements

[表 3](#) lists the design requirements.

**表 3. Design Parameters**

PARAMETER	DESIGN REQUIREMENT
Input voltage	4.2 V to 3 V (Lithium Ion battery)
Output voltage	1.8 V, ±1%
DC output current	10 mA
Peak output current	75 mA
Maximum ambient temperature	65°C

### 8.2.2 Detailed Design Procedure

An input capacitor is not required for this design because of the low impedance connection directly to the battery.

A small output capacitor allows for the minimal possible inrush current during start-up, and makes sure that the 180-mA maximum input current limit is not exceeded.

See [图 29](#) to verify that the maximum junction temperature is not exceeded.

### 8.2.3 Application Curves

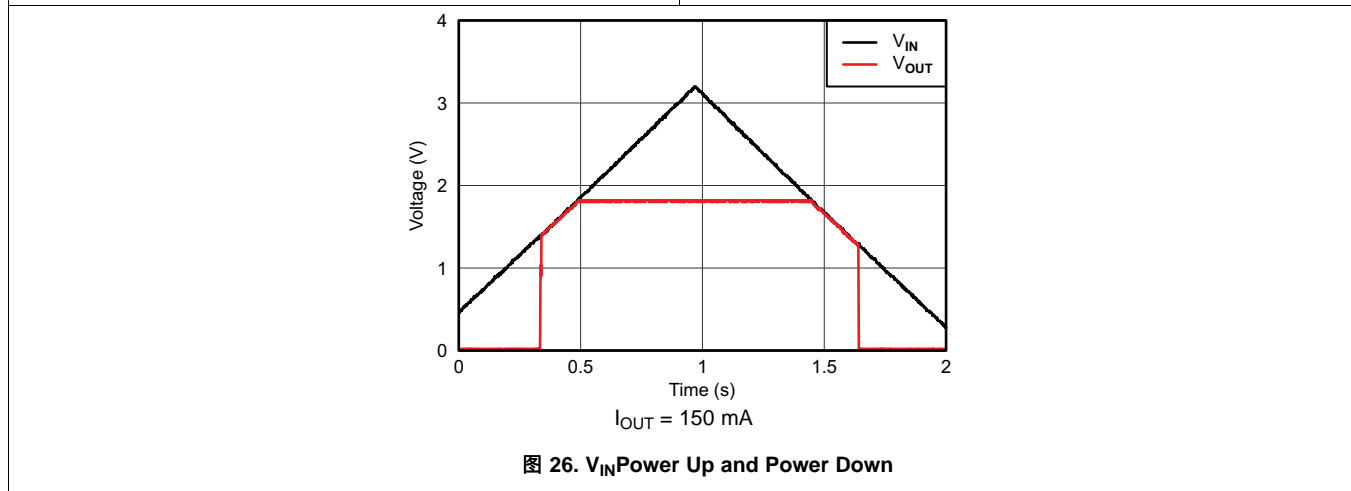
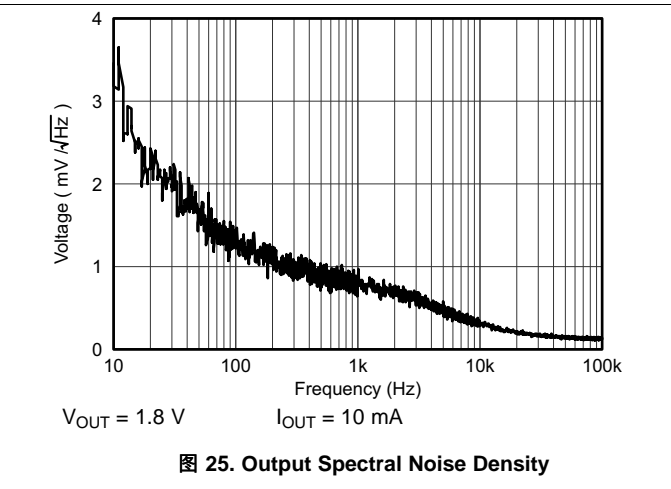
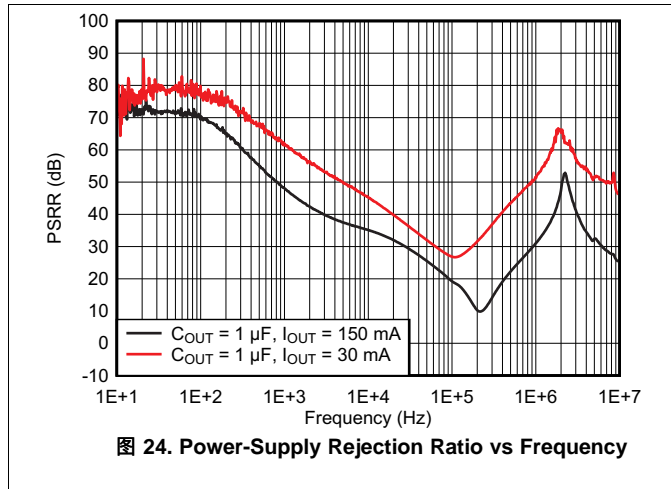

### 8.3 What to Do and What Not to Do

Place at least one 1-µF ceramic capacitor as close as possible to the OUT pin of the regulator for best transient performance.

Place at least one 1-µF capacitor as close as possible to the IN pin for best transient performance.

Do not place the output capacitor more than 10 mm away from the regulator.

Do not exceed the absolute maximum ratings.

Do not continuously operate the device in current limit or near thermal shutdown.



## 9 Power Supply Recommendations

This device is designed to operate from an input voltage supply range from 1.4 V to 5.5 V. The input voltage range must provide adequate headroom for the device to have a regulated output. This input supply must be well-regulated and stable. If the input supply is noisy, additional input capacitors with low ESR can help improve the output noise performance.

## 10 Layout

### 10.1 Layout Guidelines

#### 10.1.1 Board Layout Recommendations to Improve PSRR and Noise Performance

Input and output capacitors must be placed as close to the device pins as possible. To improve AC performance (such as PSRR, output noise, and transient response), TI recommends that the board be designed with separate ground planes for  $V_{IN}$  and  $V_{OUT}$ , with the ground plane connected only at the device GND pin. In addition, the output capacitor ground connection must be connected directly to the device GND pin. High-ESR capacitors may degrade PSRR performance.

### 10.2 Layout Examples

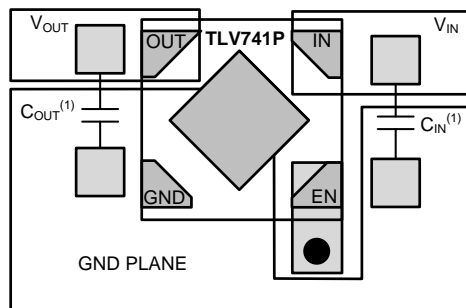

● Represents via used for application-specific connections

(1) Not required.

图 27. X2SON Layout Example

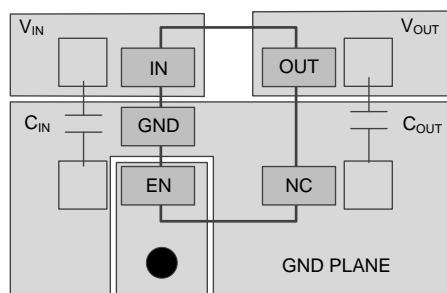

● Represents via used for application-specific connections

图 28. SOT-23 Layout Example

### 10.3 Power Dissipation

The ability to remove heat from the die is different for each package type, presenting different considerations in the printed-circuit-board (PCB) layout. The PCB area around the device that is free of other components moves the heat from the device to the ambient air. Performance data for JEDEC low- and high-K boards are given in [Thermal Information](#). Using heavier copper increases the effectiveness in removing heat from the device. The addition of plated through-holes to heat-dissipating layers also improves the heat sink effectiveness.

Power dissipation depends on input voltage and load conditions. Power dissipation ( $P_D$ ) can be approximated by the product of the output current times the voltage drop across the output pass element ( $V_{IN}$  to  $V_{OUT}$ ), as shown in [公式 3](#):

$$P_D = (V_{IN} - V_{OUT}) \times I_{OUT} \tag{3}$$

[图 29](#) shows the maximum ambient temperature versus the power dissipation of the TLV741P. This figure assumes the device is soldered on a JEDEC standard, high-K layout with no airflow over the board. Actual board thermal impedances vary widely. If the application requires high power dissipation, having a thorough understanding of the board temperature and thermal impedances is helpful to make sure the TLV741P does not operate above a junction temperature of 125°C.

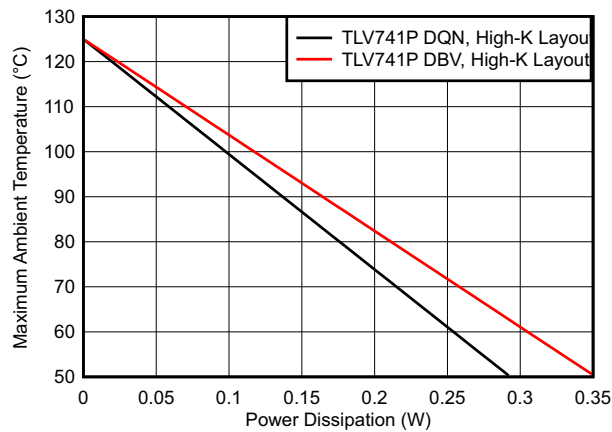

**图 29. Maximum Ambient Temperature vs Device Power Dissipation**

Estimate junction temperature by using the  $\Psi_{JT}$  and  $\Psi_{JB}$  thermal metrics, shown in [Thermal Information](#). These metrics are a more accurate representation of the heat transfer characteristics of the die and the package than  $R_{\theta JA}$ . The junction temperature can be estimated with [公式 4](#):

$$\Psi_{JT}: T_J = T_T + \Psi_{JT} \cdot P_D$$

$$\Psi_{JB}: T_J = T_B + \Psi_{JB} \cdot P_D$$

where

- $P_D$  is the power dissipation shown by [公式 3](#),
- $T_T$  is the temperature at the center-top of the device package,
- $T_B$  is the PCB temperature measured 1 mm away from the device package on the PCB surface. (4)

**注**

Both  $T_T$  and  $T_B$  can be measured on actual application boards using a thermogun (an infrared thermometer).

For more information about measuring  $T_T$  and  $T_B$ , see [Using New Thermal Metrics](#), available for download at [www.ti.com](http://www.ti.com).

## 11 器件和文档支持

### 11.1 文档支持

#### 11.1.1 相关文档

请参阅如下相关文档：

[通用低压降 \(LDO\) 线性稳压器 EVM 用户指南](#)

### 11.2 接收文档更新通知

要接收文档更新通知，请导航至 [TI.com.cn](http://TI.com.cn) 上的器件产品文件夹。单击右上角的 [通知我](#) 进行注册，即可每周接收产品信息更改摘要。有关更改的详细信息，请查看任何已修订文档中包含的修订历史记录。

### 11.3 社区资源

下列链接提供到 TI 社区资源的连接。链接的内容由各个分销商“按照原样”提供。这些内容并不构成 TI 技术规范，并且不一定反映 TI 的观点；请参阅 TI 的 [《使用条款》](#)。

**TI E2E™ 在线社区** [TI 的工程师对工程师 \(E2E\) 社区](#)。此社区的创建目的在于促进工程师之间的协作。在 [e2e.ti.com](http://e2e.ti.com) 中，您可以咨询问题、分享知识、拓展思路并与同行工程师一道帮助解决问题。

**设计支持** [TI 参考设计支持](#) 可帮助您快速查找有帮助的 E2E 论坛、设计支持工具以及技术支持的联系信息。

### 11.4 商标

E2E is a trademark of Texas Instruments.

All other trademarks are the property of their respective owners.

### 11.5 静电放电警告



ESD 可能会损坏该集成电路。德州仪器 (TI) 建议通过适当的预防措施处理所有集成电路。如果不遵守正确的处理措施和安装程序，可能会损坏集成电路。

ESD 的损坏小至导致微小的性能降级，大至整个器件故障。精密的集成电路可能更容易受到损坏，这是因为非常细微的参数更改都可能会导致器件与其发布的规格不相符。

### 11.6 术语表

[SLYZ022](#) — *TI 术语表*。

这份术语表列出并解释术语、缩写和定义。

## 12 机械、封装和可订购信息

以下页面包含机械、封装和可订购信息。这些信息是指定器件的最新可用数据。数据如有变更，恕不另行通知，且不会对此文档进行修订。如需获取此数据表的浏览器版本，请查阅左侧的导航栏。

**PACKAGING INFORMATION**

Orderable Device	Status (1)	Package Type	Package Drawing	Pins	Package Qty	Eco Plan (2)	Lead finish/ Ball material (6)	MSL Peak Temp (3)	Op Temp (°C)	Device Marking (4/5)	Samples
TLV741105PDBVR	ACTIVE	SOT-23	DBV	5	3000	RoHS & Green	SN	Level-1-260C-UNLIM	-40 to 125	1NFT	<a href="#">Samples</a>
TLV74110PDBVR	ACTIVE	SOT-23	DBV	5	3000	RoHS & Green	SN	Level-1-260C-UNLIM	-40 to 125	1C9T	<a href="#">Samples</a>
TLV74110PDQNR	ACTIVE	X2SON	DQN	4	3000	RoHS & Green	NIPDAU	Level-1-260C-UNLIM	-40 to 125	8T	<a href="#">Samples</a>
TLV74111PDBVR	ACTIVE	SOT-23	DBV	5	3000	RoHS & Green	SN	Level-1-260C-UNLIM	-40 to 125	1DHT	<a href="#">Samples</a>
TLV74111PDQNR	ACTIVE	X2SON	DQN	4	3000	RoHS & Green	NIPDAU	Level-1-260C-UNLIM	-40 to 125	8R	<a href="#">Samples</a>
TLV74112PDBVR	ACTIVE	SOT-23	DBV	5	3000	RoHS & Green	SN	Level-1-260C-UNLIM	-40 to 125	1DIT	<a href="#">Samples</a>
TLV74112PDQNR	ACTIVE	X2SON	DQN	4	3000	RoHS & Green	NIPDAU	Level-1-260C-UNLIM	-40 to 125	8Q	<a href="#">Samples</a>
TLV74115PDBVR	ACTIVE	SOT-23	DBV	5	3000	RoHS & Green	SN	Level-1-260C-UNLIM	-40 to 125	1DJT	<a href="#">Samples</a>
TLV74115PDQNR	ACTIVE	X2SON	DQN	4	3000	RoHS & Green	NIPDAU	Level-1-260C-UNLIM	-40 to 125	8P	<a href="#">Samples</a>
TLV74118PDBVR	ACTIVE	SOT-23	DBV	5	3000	RoHS & Green	SN	Level-1-260C-UNLIM	-40 to 125	1DKT	<a href="#">Samples</a>
TLV74118PDQNR	ACTIVE	X2SON	DQN	4	3000	RoHS & Green	NIPDAU	Level-1-260C-UNLIM	-40 to 125	8O	<a href="#">Samples</a>
TLV74125PDBVR	ACTIVE	SOT-23	DBV	5	3000	RoHS & Green	SN	Level-1-260C-UNLIM	-40 to 125	1DLT	<a href="#">Samples</a>
TLV74125PDQNR	ACTIVE	X2SON	DQN	4	3000	RoHS & Green	NIPDAU	Level-1-260C-UNLIM	-40 to 125	8N	<a href="#">Samples</a>
TLV741285PDBVR	ACTIVE	SOT-23	DBV	5	3000	RoHS & Green	SN	Level-1-260C-UNLIM	-40 to 125	1DMT	<a href="#">Samples</a>
TLV741285PDQNR	ACTIVE	X2SON	DQN	4	3000	RoHS & Green	NIPDAU	Level-1-260C-UNLIM	-40 to 125	8M	<a href="#">Samples</a>
TLV74128PDBVR	ACTIVE	SOT-23	DBV	5	3000	RoHS & Green	SN	Level-1-260C-UNLIM	-40 to 125	1DNT	<a href="#">Samples</a>
TLV74128PDQNR	ACTIVE	X2SON	DQN	4	3000	RoHS & Green	NIPDAU	Level-1-260C-UNLIM	-40 to 125	8L	<a href="#">Samples</a>
TLV74130PDBVR	ACTIVE	SOT-23	DBV	5	3000	RoHS & Green	SN	Level-1-260C-UNLIM	-40 to 125	1DOT	<a href="#">Samples</a>
TLV74130PDQNR	ACTIVE	X2SON	DQN	4	3000	RoHS & Green	NIPDAU	Level-1-260C-UNLIM	-40 to 125	8K	<a href="#">Samples</a>
TLV74133PDBVR	ACTIVE	SOT-23	DBV	5	3000	RoHS & Green	SN	Level-1-260C-UNLIM	-40 to 125	1CAT	<a href="#">Samples</a>

Orderable Device	Status (1)	Package Type	Package Drawing	Pins	Package Qty	Eco Plan (2)	Lead finish/ Ball material (6)	MSL Peak Temp (3)	Op Temp (°C)	Device Marking (4/5)	Samples
TLV74133PDQNR	ACTIVE	X2SON	DQN	4	3000	RoHS & Green	NIPDAU	Level-1-260C-UNLIM	-40 to 125	8J	Samples

(1) The marketing status values are defined as follows:

**ACTIVE:** Product device recommended for new designs.

**LIFEBUY:** TI has announced that the device will be discontinued, and a lifetime-buy period is in effect.

**NRND:** Not recommended for new designs. Device is in production to support existing customers, but TI does not recommend using this part in a new design.

**PREVIEW:** Device has been announced but is not in production. Samples may or may not be available.

**OBSOLETE:** TI has discontinued the production of the device.

(2) **RoHS:** TI defines "RoHS" to mean semiconductor products that are compliant with the current EU RoHS requirements for all 10 RoHS substances, including the requirement that RoHS substance do not exceed 0.1% by weight in homogeneous materials. Where designed to be soldered at high temperatures, "RoHS" products are suitable for use in specified lead-free processes. TI may reference these types of products as "Pb-Free".

**RoHS Exempt:** TI defines "RoHS Exempt" to mean products that contain lead but are compliant with EU RoHS pursuant to a specific EU RoHS exemption.

**Green:** TI defines "Green" to mean the content of Chlorine (Cl) and Bromine (Br) based flame retardants meet JS709B low halogen requirements of <=1000ppm threshold. Antimony trioxide based flame retardants must also meet the <=1000ppm threshold requirement.

(3) MSL, Peak Temp. - The Moisture Sensitivity Level rating according to the JEDEC industry standard classifications, and peak solder temperature.

(4) There may be additional marking, which relates to the logo, the lot trace code information, or the environmental category on the device.

(5) Multiple Device Markings will be inside parentheses. Only one Device Marking contained in parentheses and separated by a "~" will appear on a device. If a line is indented then it is a continuation of the previous line and the two combined represent the entire Device Marking for that device.

(6) Lead finish/Ball material - Orderable Devices may have multiple material finish options. Finish options are separated by a vertical ruled line. Lead finish/Ball material values may wrap to two lines if the finish value exceeds the maximum column width.

**Important Information and Disclaimer:** The information provided on this page represents TI's knowledge and belief as of the date that it is provided. TI bases its knowledge and belief on information provided by third parties, and makes no representation or warranty as to the accuracy of such information. Efforts are underway to better integrate information from third parties. TI has taken and continues to take reasonable steps to provide representative and accurate information but may not have conducted destructive testing or chemical analysis on incoming materials and chemicals. TI and TI suppliers consider certain information to be proprietary, and thus CAS numbers and other limited information may not be available for release.

In no event shall TI's liability arising out of such information exceed the total purchase price of the TI part(s) at issue in this document sold by TI to Customer on an annual basis.

**TAPE AND REEL INFORMATION**

**QUADRANT ASSIGNMENTS FOR PIN 1 ORIENTATION IN TAPE**

\*All dimensions are nominal

Device	Package Type	Package Drawing	Pins	SPQ	Reel Diameter (mm)	Reel Width W1 (mm)	A0 (mm)	B0 (mm)	K0 (mm)	P1 (mm)	W (mm)	Pin1 Quadrant
TLV741105PDBVR	SOT-23	DBV	5	3000	178.0	9.0	3.3	3.2	1.4	4.0	8.0	Q3
TLV74110PDBVR	SOT-23	DBV	5	3000	178.0	9.0	3.3	3.2	1.4	4.0	8.0	Q3
TLV74110PDQNR	X2SON	DQN	4	3000	180.0	8.4	1.16	1.16	0.53	2.0	8.0	Q2
TLV74111PDBVR	SOT-23	DBV	5	3000	178.0	9.0	3.3	3.2	1.4	4.0	8.0	Q3
TLV74111PDQNR	X2SON	DQN	4	3000	180.0	8.4	1.16	1.16	0.53	2.0	8.0	Q2
TLV74112PDBVR	SOT-23	DBV	5	3000	178.0	9.0	3.3	3.2	1.4	4.0	8.0	Q3
TLV74112PDQNR	X2SON	DQN	4	3000	180.0	8.4	1.16	1.16	0.53	2.0	8.0	Q2
TLV74115PDBVR	SOT-23	DBV	5	3000	178.0	9.0	3.3	3.2	1.4	4.0	8.0	Q3
TLV74115PDQNR	X2SON	DQN	4	3000	180.0	8.4	1.16	1.16	0.53	2.0	8.0	Q2
TLV74118PDBVR	SOT-23	DBV	5	3000	178.0	9.0	3.3	3.2	1.4	4.0	8.0	Q3
TLV74118PDQNR	X2SON	DQN	4	3000	180.0	8.4	1.16	1.16	0.53	2.0	8.0	Q2
TLV74125PDBVR	SOT-23	DBV	5	3000	178.0	9.0	3.3	3.2	1.4	4.0	8.0	Q3
TLV74125PDQNR	X2SON	DQN	4	3000	180.0	8.4	1.16	1.16	0.53	2.0	8.0	Q2
TLV741285PDBVR	SOT-23	DBV	5	3000	178.0	9.0	3.3	3.2	1.4	4.0	8.0	Q3
TLV741285PDQNR	X2SON	DQN	4	3000	180.0	8.4	1.16	1.16	0.53	2.0	8.0	Q2
TLV74128PDBVR	SOT-23	DBV	5	3000	178.0	9.0	3.3	3.2	1.4	4.0	8.0	Q3
TLV74128PDQNR	X2SON	DQN	4	3000	180.0	8.4	1.16	1.16	0.53	2.0	8.0	Q2
TLV74130PDBVR	SOT-23	DBV	5	3000	178.0	9.0	3.3	3.2	1.4	4.0	8.0	Q3

Device	Package Type	Package Drawing	Pins	SPQ	Reel Diameter (mm)	Reel Width W1 (mm)	A0 (mm)	B0 (mm)	K0 (mm)	P1 (mm)	W (mm)	Pin1 Quadrant
TLV74130PDQNR	X2SON	DQN	4	3000	180.0	8.4	1.16	1.16	0.53	2.0	8.0	Q2
TLV74133PDBVR	SOT-23	DBV	5	3000	178.0	9.0	3.3	3.2	1.4	4.0	8.0	Q3
TLV74133PDQNR	X2SON	DQN	4	3000	180.0	8.4	1.16	1.16	0.53	2.0	8.0	Q2

## TAPE AND REEL BOX DIMENSIONS

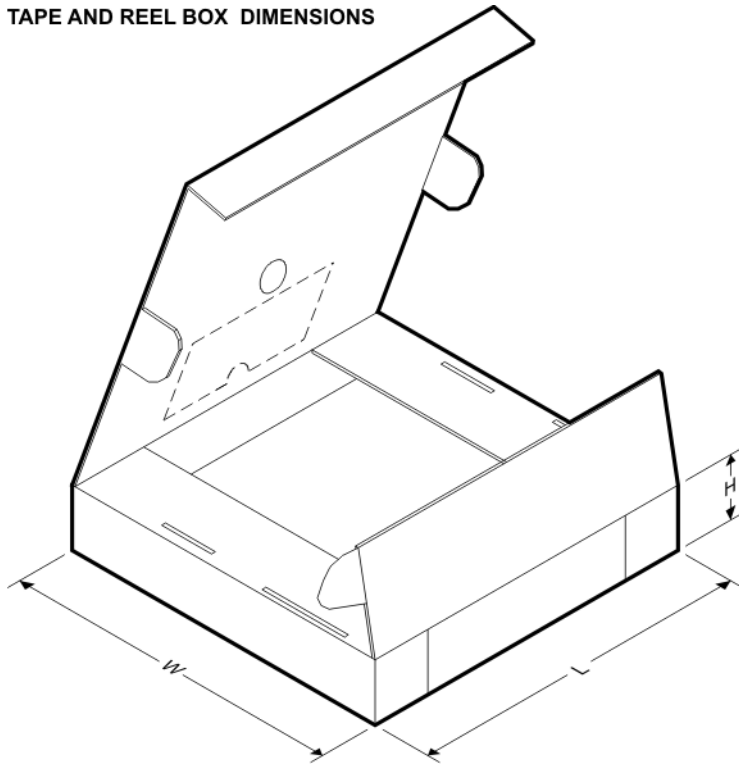

\*All dimensions are nominal

Device	Package Type	Package Drawing	Pins	SPQ	Length (mm)	Width (mm)	Height (mm)
TLV741105PDBVR	SOT-23	DBV	5	3000	180.0	180.0	18.0
TLV741110PDBVR	SOT-23	DBV	5	3000	180.0	180.0	18.0
TLV741110PDQNR	X2SON	DQN	4	3000	203.2	196.8	33.3
TLV741111PDBVR	SOT-23	DBV	5	3000	180.0	180.0	18.0
TLV741111PDQNR	X2SON	DQN	4	3000	203.2	196.8	33.3
TLV741112PDBVR	SOT-23	DBV	5	3000	180.0	180.0	18.0
TLV741112PDQNR	X2SON	DQN	4	3000	203.2	196.8	33.3
TLV741115PDBVR	SOT-23	DBV	5	3000	180.0	180.0	18.0
TLV741115PDQNR	X2SON	DQN	4	3000	203.2	196.8	33.3
TLV741118PDBVR	SOT-23	DBV	5	3000	180.0	180.0	18.0
TLV741118PDQNR	X2SON	DQN	4	3000	203.2	196.8	33.3
TLV74125PDBVR	SOT-23	DBV	5	3000	180.0	180.0	18.0
TLV74125PDQNR	X2SON	DQN	4	3000	203.2	196.8	33.3
TLV741285PDBVR	SOT-23	DBV	5	3000	180.0	180.0	18.0

---

Device	Package Type	Package Drawing	Pins	SPQ	Length (mm)	Width (mm)	Height (mm)
TLV741285PDQNR	X2SON	DQN	4	3000	203.2	196.8	33.3
TLV74128PDBVR	SOT-23	DBV	5	3000	180.0	180.0	18.0
TLV74128PDQNR	X2SON	DQN	4	3000	203.2	196.8	33.3
TLV74130PDBVR	SOT-23	DBV	5	3000	180.0	180.0	18.0
TLV74130PDQNR	X2SON	DQN	4	3000	203.2	196.8	33.3
TLV74133PDBVR	SOT-23	DBV	5	3000	180.0	180.0	18.0
TLV74133PDQNR	X2SON	DQN	4	3000	203.2	196.8	33.3







# EXAMPLE STENCIL DESIGN

DBV0005A

SOT-23 - 1.45 mm max height

SMALL OUTLINE TRANSISTOR



SOLDER PASTE EXAMPLE  
BASED ON 0.125 mm THICK STENCIL  
SCALE:15X

4214839/F 06/2021

NOTES: (continued)

7. Laser cutting apertures with trapezoidal walls and rounded corners may offer better paste release. IPC-7525 may have alternate design recommendations.
8. Board assembly site may have different recommendations for stencil design.

## GENERIC PACKAGE VIEW

DQN 4

**X2SON - 0.4 mm max height**

PLASTIC SMALL OUTLINE - NO LEAD



Images above are just a representation of the package family, actual package may vary.  
Refer to the product data sheet for package details.

4210367/F



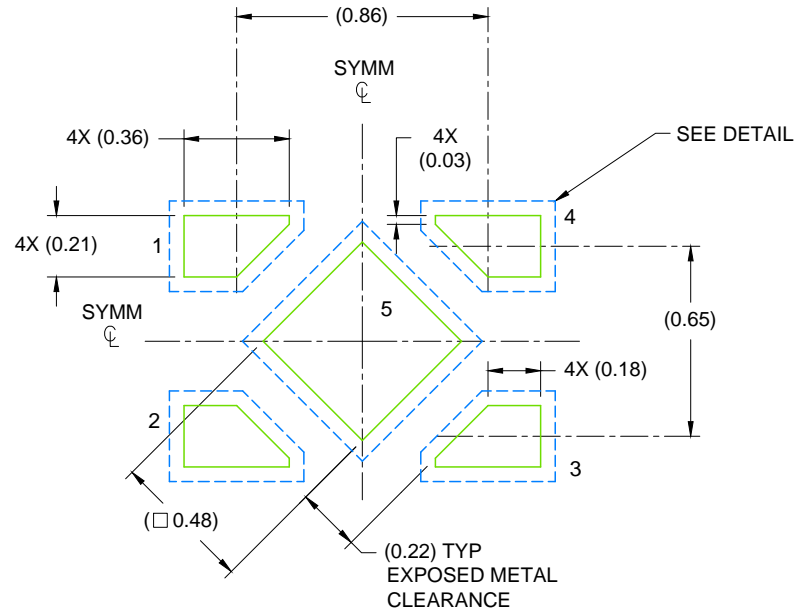

LAND PATTERN EXAMPLE  
SCALE: 40X

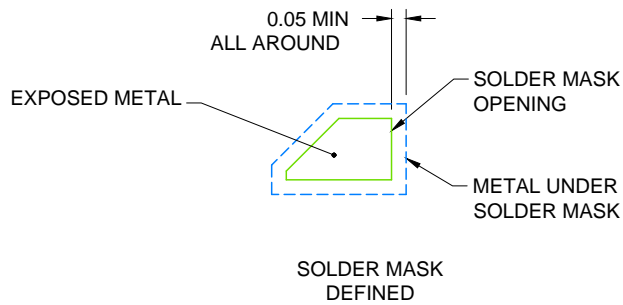

SOLDER MASK DETAIL

4215302/E 12/2016

NOTES: (continued)

7. This package is designed to be soldered to a thermal pad on the board. For more information, see Texas Instruments literature number SLUA271 ([www.ti.com/lit/sluea271](http://www.ti.com/lit/sluea271)).
8. If any vias are implemented, it is recommended that vias under paste be filled, plugged or tented.

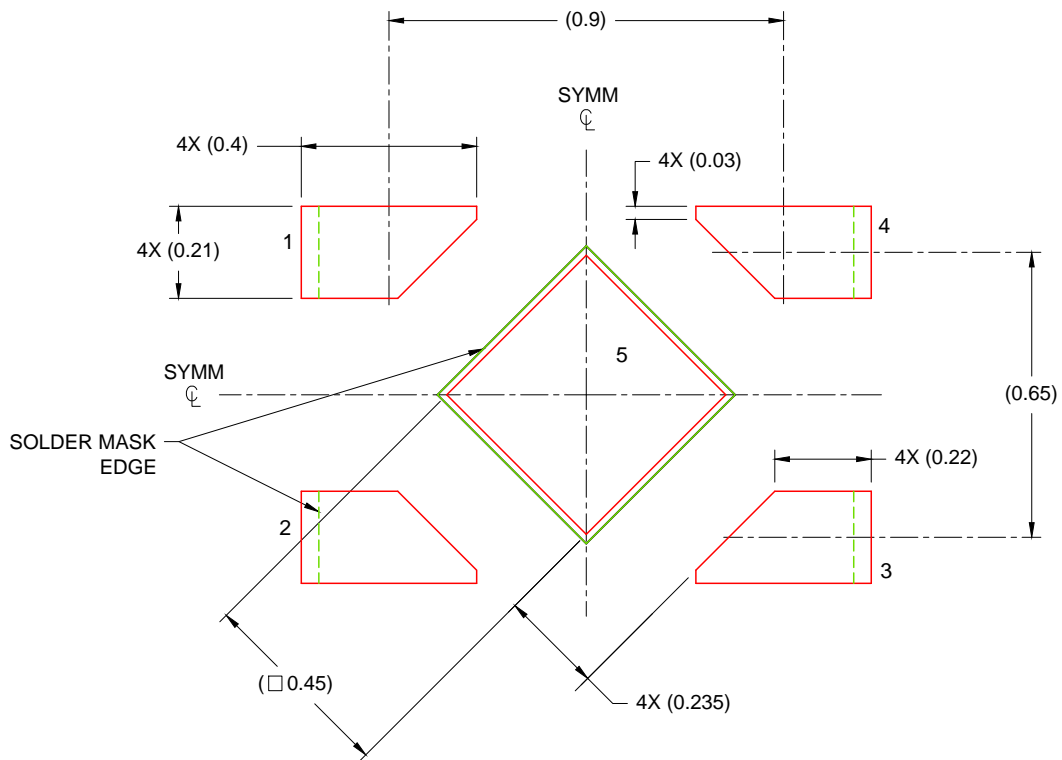

SOLDER PASTE EXAMPLE  
 BASED ON 0.075 - 0.1mm THICK STENCIL  
 EXPOSED PAD  
 88% PRINTED SOLDER COVERAGE BY AREA  
 SCALE: 60X

4215302/E 12/2016

NOTES: (continued)

- 9. Laser cutting apertures with trapezoidal walls and rounded corners may offer better paste release. IPC-7525 may have alternate design recommendations.

## 重要声明和免责声明

TI“按原样”提供技术和可靠性数据（包括数据表）、设计资源（包括参考设计）、应用或其他设计建议、网络工具、安全信息和其他资源，不保证没有瑕疵且不做任何明示或暗示的担保，包括但不限于对适销性、某特定用途方面的适用性或不侵犯任何第三方知识产权的暗示担保。

这些资源可供使用 TI 产品进行设计的熟练开发人员使用。您将自行承担以下全部责任：(1) 针对您的应用选择合适的 TI 产品，(2) 设计、验证并测试您的应用，(3) 确保您的应用满足相应标准以及任何其他功能安全、信息安全、监管或其他要求。

这些资源如有变更，恕不另行通知。TI 授权您仅可将这些资源用于研发本资源所述的 TI 产品的应用。严禁对这些资源进行其他复制或展示。您无权使用任何其他 TI 知识产权或任何第三方知识产权。您应全额赔偿因在这些资源的使用中对 TI 及其代表造成的任何索赔、损害、成本、损失和债务，TI 对此概不负责。

TI 提供的产品受 [TI 的销售条款](#) 或 [ti.com](#) 上其他适用条款/TI 产品随附的其他适用条款的约束。TI 提供这些资源并不会扩展或以其他方式更改 TI 针对 TI 产品发布的适用的担保或担保免责声明。

TI 反对并拒绝您可能提出的任何其他或不同的条款。

邮寄地址：Texas Instruments, Post Office Box 655303, Dallas, Texas 75265  
Copyright © 2021，德州仪器 (TI) 公司