

**VOLTAGE RANGE: 50 - 600V**  
**CURRENT: 3.0 A**

### Features

- Glass Passivated Die Construction
- Ideally Suited for Automatic Assembly
- Low Forward Voltage Drop, High Efficiency
- Low Power Loss
- Super-Fast Recovery Time
- Plastic Case Material has UL Flammability Classification Rating 94V-0

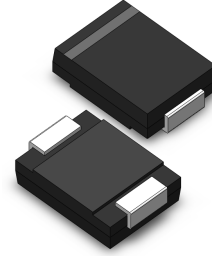

### Mechanical Data

- Case: SMC/DO-214AB, Molded Plastic
- Terminals: Solder Plated, Solderable per MIL-STD-750, Method 2026
- Polarity: Cathode Band or Cathode Notch
- Marking: Type Number
- Weight: 0.21 grams (approx.)

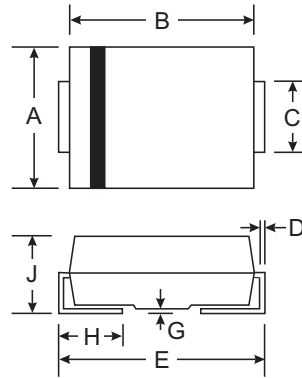

SMC/DO-214AB		
Dim	Min	Max
A	5.59	6.22
B	6.60	7.11
C	2.75	3.18
D	0.15	0.31
E	7.75	8.13
G	0.10	0.20
H	0.76	1.52
J	2.00	2.62
All Dimensions in mm		

### Maximum Ratings and Electrical Characteristics T<sub>A</sub> = 25°C unless otherwise specified

Single phase, half wave, 60Hz, resistive or inductive load. For capacitive load, derate current by 20%.

Characteristic	Symbol	MURS305	MURS310	MURS315	MURS320	MURS330	MURS340	MURS360	Unit
Peak Repetitive Reverse Voltage	V <sub>RRM</sub>								
Working Peak Reverse Voltage	V <sub>RWM</sub>	50	100	150	200	300	400	600	V
DC Blocking Voltage	V <sub>R</sub>								
RMS Reverse Voltage	V <sub>R(RMS)</sub>	35	70	105	140	210	280	420	V
Average Rectified Output Current @T <sub>L</sub> = 75°C	I <sub>O</sub>	3.0							A
Non-Repetitive Peak Forward Surge Current 8.3ms Single half sine-wave superimposed on rated load (JEDEC Method)	I <sub>FSM</sub>	100							A
Forward Voltage @I <sub>F</sub> = 3.0A	V <sub>FM</sub>	0.95				1.25		1.7	V
Peak Reverse Current @T <sub>A</sub> = 25°C At Rated DC Blocking Voltage @T <sub>A</sub> = 100°C	I <sub>RM</sub>	5.0					500		μA
Reverse Recovery Time (Note 1)	t <sub>rr</sub>	35					nS		
Typical Junction Capacitance (Note 2)	C <sub>j</sub>	45					pF		
Typical Thermal Resistance (Note 3)	R <sub>θJL</sub>	16					°C/W		
Operating and Storage Temperature Range	T <sub>j</sub> , T <sub>STG</sub>	-65 to +150							°C

- Note: 1. Measured with I<sub>F</sub> = 0.5A, I<sub>R</sub> = 1.0A, I<sub>rr</sub> = 0.25A. See figure 5.  
 2. Measured at 1.0 MHz and applied reverse voltage of 4.0 V DC.  
 3. Mounted on P.C. Board with 8.0mm<sup>2</sup> land area.

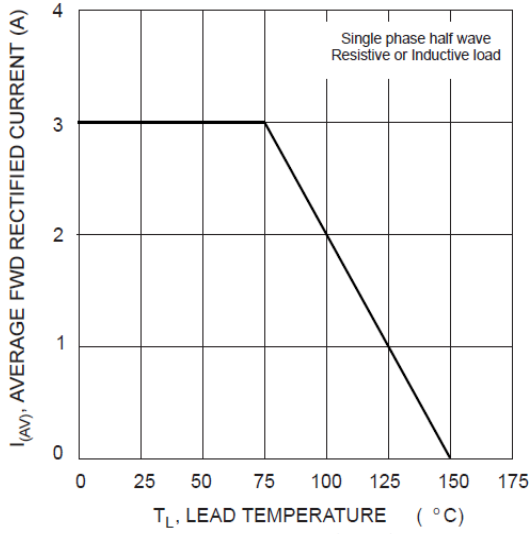

Fig. 1 Forward Current Derating Curve

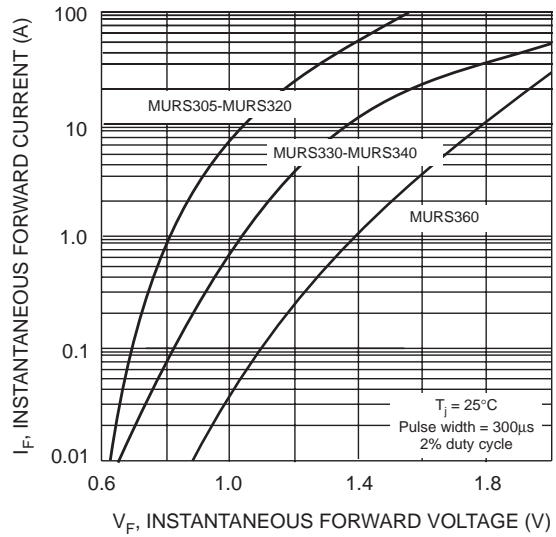

Fig. 2 Typical Forward Characteristics

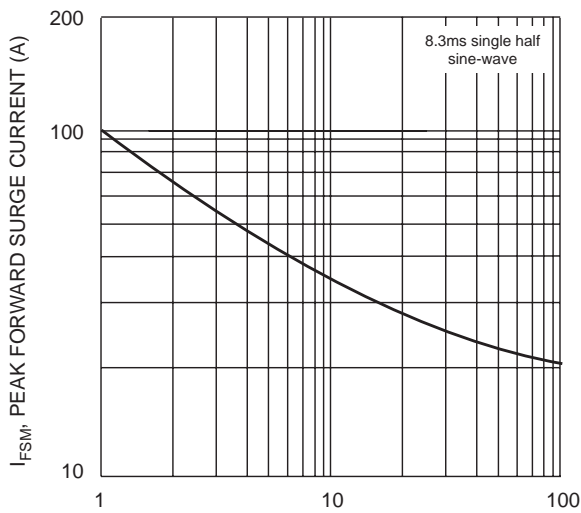

Fig. 3 Peak Forward Surge Current

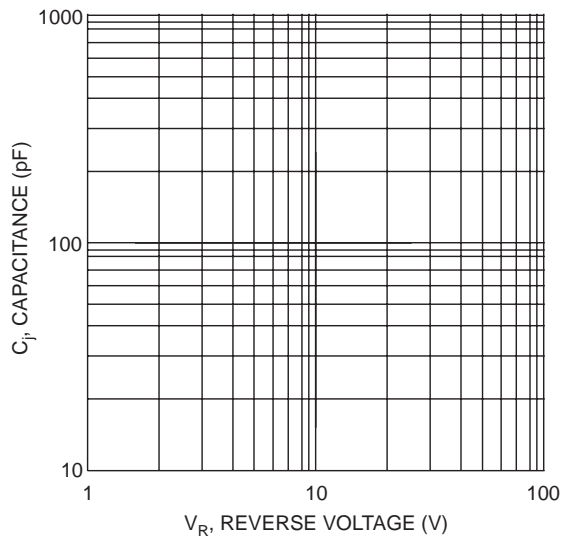
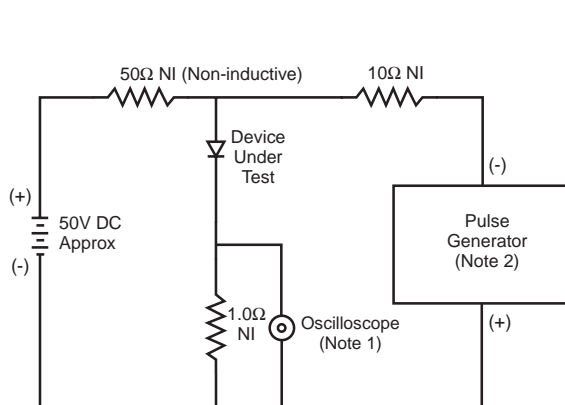
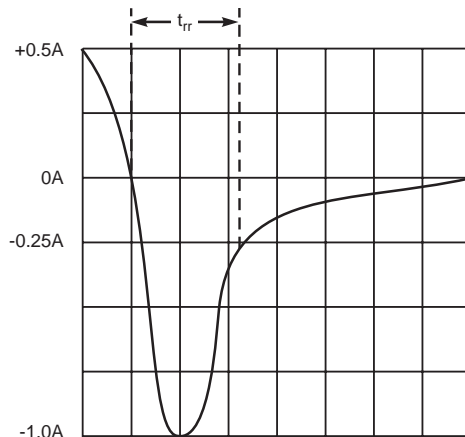

Fig. 4 Typical Junction Capacitance



- Notes:
1. Rise Time = 7.0ns max. Input Impedance = 1.0MΩ, 22pF.
  2. Rise Time = 10ns max. Input Impedance = 50Ω.



Set time base for 5/10ns/cm

Fig. 5 Reverse Recovery Time Characteristic and Test Circuit