

VOLTAGE RANGE: 50-1000V
CURRENT: 3.0 A

Features

- Glass Passivated Die Construction
- Fast Recovery Time for High Efficiency
Low Forward Voltage Drop and High Current Capability
- Ideally Suited for Automatic Assembly
- Plastic Material: UL Flammability
- Classification Rating 94V-0

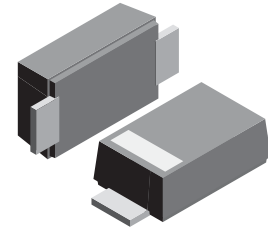

Mechanical Data

- Case: SMBF, Molded Plastic
- Terminals: Solder Plated, Solderable per MIL-STD-750, Method 2026
- Polarity: Cathode Band or Cathode Notch
- Marking: Type Number
- Weight: 0.0018 ounces, 0.05 grams

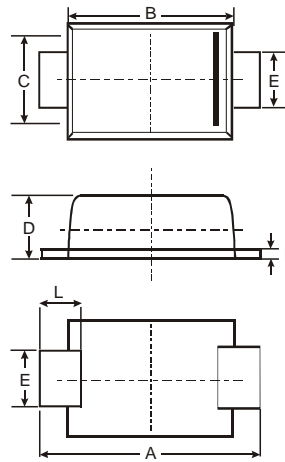

SMBF			
Dim	Min	Max	Typ
A	5.45	5.55	5.50
B	4.27	4.33	4.30
C	3.57	3.63	3.60
D	1.32	1.38	1.35
E	1.96	2.00	1.98
H	0.019	0.021	0.20
L	0.73	0.77	0.75
All Dimensions in mm			

Maximum Ratings and Electrical Characteristics T_A = 25°C unless otherwise specified

Single phase, half wave, 60Hz, resistive or inductive load. For capacitive load, derate current by 20%.

Characteristic	Symbol	FR3ABF	FR3BBF	FR3DBF	FR3GBF	FR3JBF	FR3KBF	FR3MBF	Unit
Peak Repetitive Reverse Voltage	V _{RRM}								
Working Peak Reverse Voltage	V _{RWM}	50	100	200	400	600	800	1000	V
DC Blocking Voltage	V _R								
RMS Reverse Voltage	V _{R(RMS)}	35	70	140	280	420	560	700	V
Average Rectified Output Current @ T _T = 75°C	I _O	3.0							A
Non-Repetitive Peak Forward Surge Current 8.3ms Single half sine-wave Superimposed on Rated Load (JEDEC Method)	I _{FSM}	100							A
Forward Voltage @ I _F = 3.0A	V _{FM}	1.3							V
Peak Reverse Current @ T _A = 25°C at Rated DC Blocking Voltage @ T _A = 125°C	I _{RM}	5.0 250							μA
Maximum Recovery Time (Note 3)	t _{rr}	150				250	500		ns
Typical Junction Capacitance (Note 2)	C _j	50							pF
Typical Thermal Resistance Junction to Terminal (Note 1)	R _{θJT}	25							K/W
Operating and Storage Temperature Range	T _j , T _{STG}	-65 to +150							°C

- Notes:
1. Thermal resistance: junction to terminal, unit mounted on PC board with 5.0 mm² (0.013 mm thick) copper pad as heat sink.
 2. Measured at 1.0MHz and applied reverse voltage of 4.0V DC.
 3. Reverse recovery test conditions: I_F = 0.5A, I_R = 1.0A, t_{rr} = 0.25A. See figure 5.

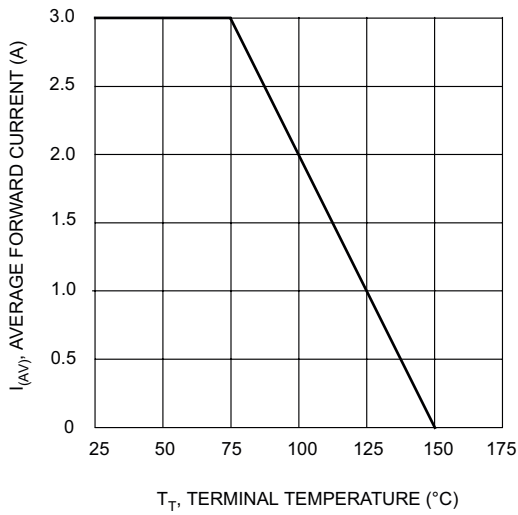

T_T , TERMINAL TEMPERATURE (°C)
Fig. 1 Forward Current Derating Curve

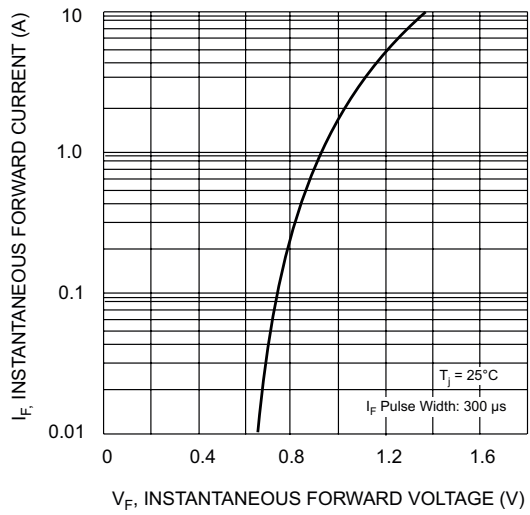

V_F , INSTANTANEOUS FORWARD VOLTAGE (V)
Fig. 2 Typical Forward Characteristics

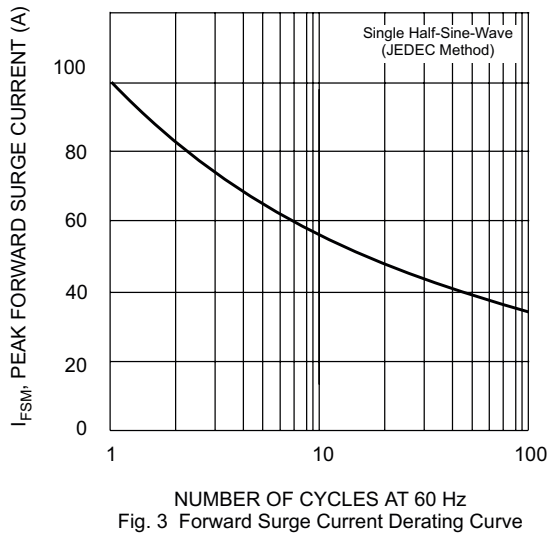

NUMBER OF CYCLES AT 60 Hz
Fig. 3 Forward Surge Current Derating Curve

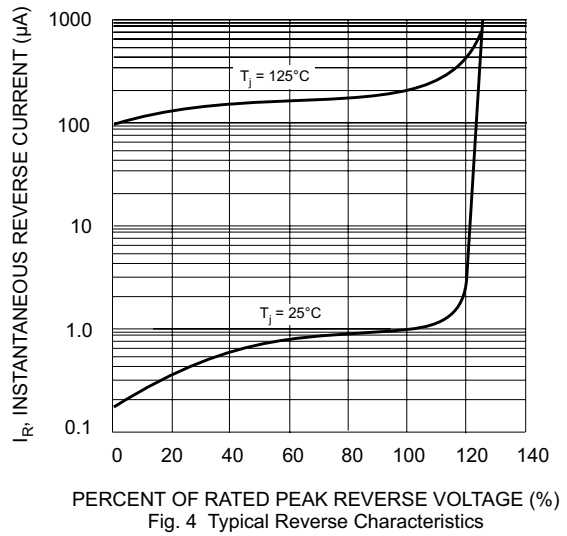

PERCENT OF RATED PEAK REVERSE VOLTAGE (%)
Fig. 4 Typical Reverse Characteristics

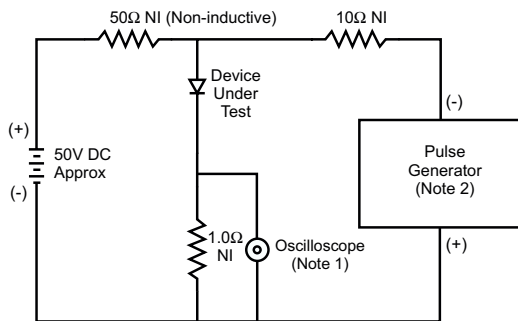

- Notes:
 1. Rise Time = 7.0ns max. Input Impedance = 1.0MΩ, 22pF.
 2. Rise Time = 10ns max. Input Impedance = 50Ω.

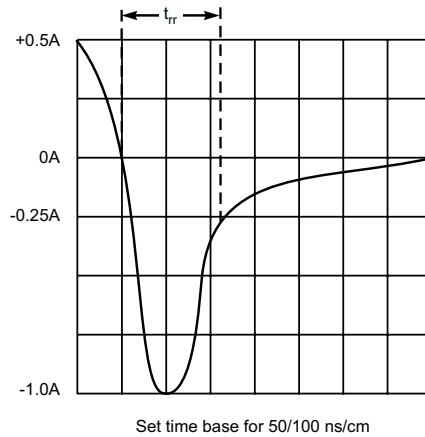

Fig. 5 Reverse Recovery Time Characteristic and Test Circuit