



TPSMF4L5.0A(CA) - TPSMF4L85A(CA)

SURFACE MOUNT TRANSIENT VOLTAGE SUPPRESSOR DIODE

VOLTAGE RANGE: 5.0 - 85V
POWER: 400Watts

Features

- For surface mounted applications
- Low profile package
- Low incremental surge resistance, excellent clamping capability
- 200W peak pulse power capability with a 10/1000 μ s wave from, repetition rate (duty cycle): 0.01%
- High temperature soldering guaranteed: 260 /10 seconds, at terminals

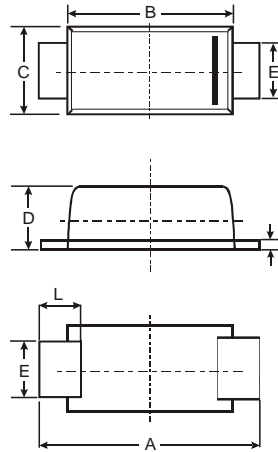
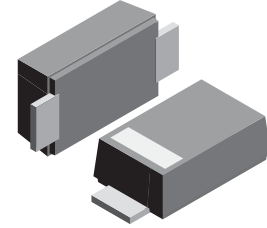

SOD-123FL			
Dim	Min	Max	Typ
A	3.58	3.72	3.65
B	2.72	2.78	2.75
C	1.77	1.83	1.80
D	1.02	1.08	1.05
E	0.097	1.03	1.00
H	0.13	0.17	0.15
L	0.53	0.57	0.55
All Dimensions in mm			

Mechanical Data

- Case: SOD-123FL plastic body over passivated junction
- Terminals : Plated axial leads, solderable per MIL-STD-750, Method 2026
- Polarity : Color band denotes cathode end
- Mounting Position : Any
- Weight: 0.0007 ounce, 0.02 grams



Maximum Ratings $T_A = 25^\circ\text{C}$ unless otherwise specified

Parameter	Symbol	Value	Unit
Peak Pulse Power Dissipation at $T_A = 25^\circ\text{C}$ (Note 1)	P_{PPM}	2000	W
8/20 (Note 2) 10/1000 μ s (Note 3)		400	W
Thermal Resistance Junction to Ambient	$R_{\theta JA}$	220	$^\circ\text{C/W}$
Thermal Resistance Junction to Lead	$R_{\theta JL}$	100	$^\circ\text{C/W}$
Operating and Storage Temperature Range	T_J, T_{STG}	-55 to 150	$^\circ\text{C}$

Notes:

1. Non-repetitive current pulse, per Fig. 4 and derated above T_J (initial) = 25°C per Fig. 3.
2. TPSMF4L5.0A~TPSMF4L9.0A Peak Pulse Power Dissipation is 1850W min, 2000W typical @8/20us
3. TPSMF4L5.0A~TPSMF4L9.0A Peak Pulse Power Dissipation is 370W min, 400W typical @10/1000 μ s



TYPE		Breakdown Voltage VBR (Volts) @ IT		Test Current IT(mA)	Reverse Stand off Voltage VR (V)	Maximum Reverse Leakage @ VR IR (µA)	Maximum Peak Pulse Current Ipp(A)	Maximum Clamping Voltage@ I VC(V)
(Uni)	(Bi)	MIN	MAX					
TPSMF4L5.0A	TPSMF4L5.0CA	6.40	7.00	10	5.0	800	40.1	9.2
TPSMF4L6.0A	TPSMF4L6.0CA	6.67	7.37	10	6.0	800	35.9	10.3
TPSMF4L6.5A	TPSMF4L6.5CA	7.22	7.98	10	6.5	500	33.1	11.2
TPSMF4L7.0A	TPSMF4L7.0CA	7.78	8.60	10	7.0	200	30.9	12.0
TPSMF4L7.5A	TPSMF4L7.5CA	8.33	9.21	1	7.5	100	28.7	12.9
TPSMF4L8.0A	TPSMF4L8.0CA	8.89	9.83	1	8.0	50	27.2	13.6
TPSMF4L8.5A	TPSMF4L8.5CA	9.44	10.40	1	8.5	20	25.7	14.4
TPSMF4L9.0A	TPSMF4L9.0CA	10.00	11.10	1	9.0	10	24.1	15.4
TPSMF4L10A	TPSMF4L10CA	11.10	12.30	1	10	5	23.5	17.0
TPSMF4L11A	TPSMF4L11CA	12.20	13.50	1	11	1	22.0	18.2
TPSMF4L12A	TPSMF4L12CA	13.30	14.70	1	12	1	20.1	19.9
TPSMF4L13A	TPSMF4L13CA	14.40	15.90	1	13	1	18.6	21.5
TPSMF4L14A	TPSMF4L14CA	15.60	17.20	1	14	1	17.2	23.2
TPSMF4L15A	TPSMF4L15CA	16.70	18.50	1	15	1	16.4	24.4
TPSMF4L16A	TPSMF4L16CA	17.80	19.70	1	16	1	15.4	26.0
TPSMF4L17A	TPSMF4L17CA	18.90	20.90	1	17	1	14.5	27.6
TPSMF4L18A	TPSMF4L18CA	20.00	22.10	1	18	1	13.7	29.2
TPSMF4L20A	TPSMF4L20CA	22.20	24.50	1	20	1	12.3	32.4
TPSMF4L22A	TPSMF4L22CA	24.40	26.90	1	22	1	11.3	35.5
TPSMF4L24A	TPSMF4L24CA	26.70	29.50	1	24	1	10.3	38.9
TPSMF4L26A	TPSMF4L26CA	28.90	31.90	1	26	1	9.5	42.1
TPSMF4L28A	TPSMF4L28CA	31.10	34.40	1	28	1	8.8	45.4
TPSMF4L30A	TPSMF4L30CA	33.30	36.80	1	30	1	8.3	48.4
TPSMF4L33A	TPSMF4L33CA	36.70	40.60	1	33	1	7.5	53.3
TPSMF4L36A	TPSMF4L36CA	40.00	44.20	1	36	1	6.9	58.1
TPSMF4L40A	TPSMF4L40CA	44.40	49.10	1	40	1	6.2	64.5
TPSMF4L43A	TPSMF4L43CA	47.80	52.80	1	43	1	5.8	69.4
TPSMF4L45A	TPSMF4L45CA	50.00	55.30	1	45	1	5.5	72.7
TPSMF4L48A	TPSMF4L48CA	53.30	58.90	1	48	1	5.2	77.4
TPSMF4L51A	TPSMF4L51CA	56.70	62.70	1	51	1	4.9	82.4
TPSMF4L54A	TPSMF4L54CA	60.00	66.30	1	54	1	4.6	87.1
TPSMF4L58A	TPSMF4L58CA	64.40	71.20	1	58	1	4.3	93.6
TPSMF4L60A	TPSMF4L60CA	66.70	73.70	1	60	1	4.1	96.8
TPSMF4L64A	TPSMF4L64CA	71.10	78.60	1	64	1	3.9	103.0
TPSMF4L70A	TPSMF4L70CA	77.80	86.00	1	70	1	3.5	113.0
TPSMF4L75A	TPSMF4L75CA	83.30	92.10	1	75	1	3.3	121.0
TPSMF4L78A	TPSMF4L78CA	86.70	95.80	1	78	1	3.2	126.0
TPSMF4L85A	TPSMF4L85CA	94.40	104.00	1	85	1	2.9	137.0



I-V Curve Characteristics

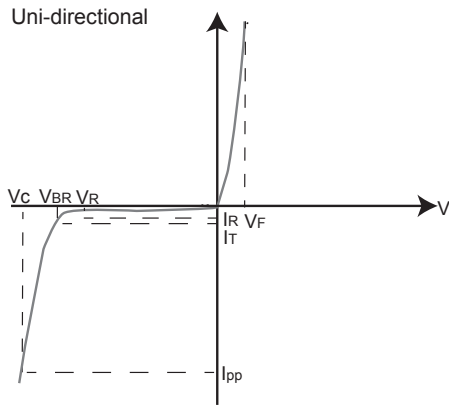

- P_{PPM} Peak Pulse Power Dissipation** – Max power dissipation
- V_R Stand-off Voltage** – Maximum voltage that can be applied to the TVS without operation
- V_{BR} Breakdown Voltage** – Maximum voltage that flows through the TVS at a specified test current (I_T)
- V_c Clamping Voltage** – Peak voltage measured across the TVS at a specified I_{ppm} (peak impulse current)
- I_R Reverse Leakage Current** – Current measured at V_R
- V_F Forward Voltage Drop for Uni-directional**

Ratings and Characteristic Curves(TA=25 °C unless otherwise noted)

Figure 1 - TVS Transients Clamping Waveform

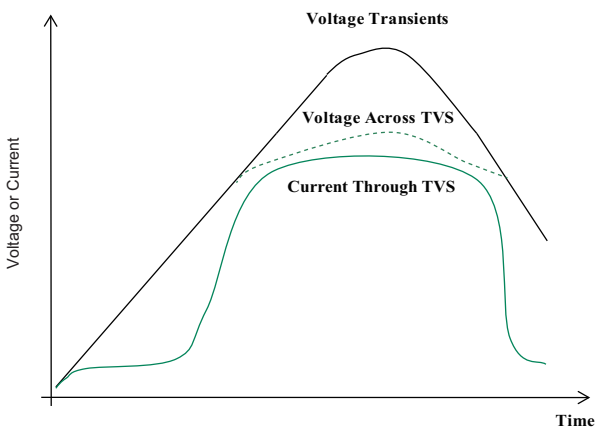

Figure 2 - Peak Pulse Power Rating Curve

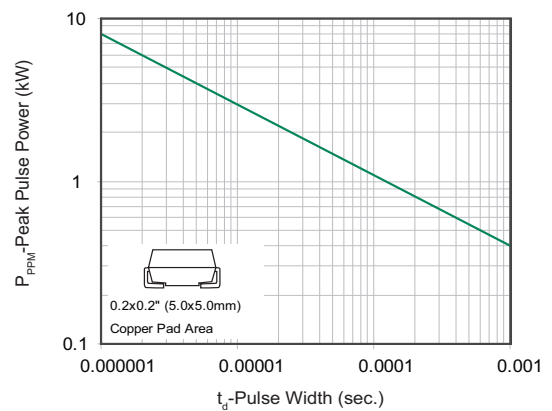



Figure 3 - Peak Pulse Power Derating Curve

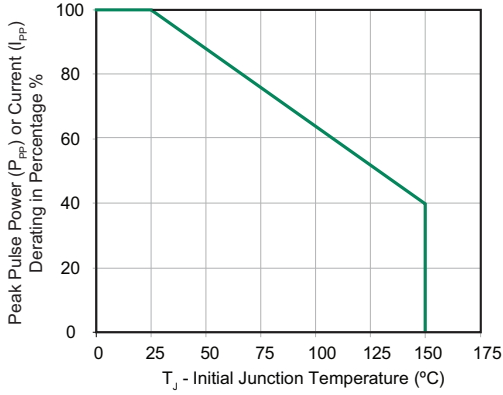

Figure 4 - Pulse Waveform - 10/1000US

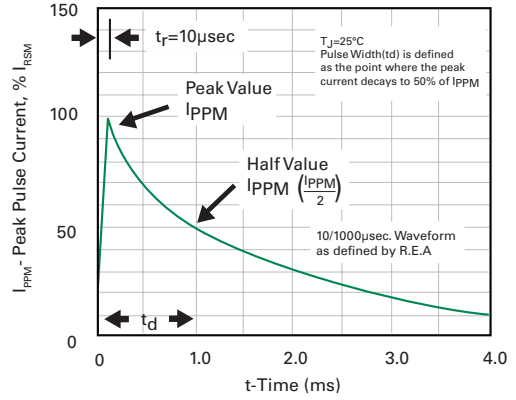

Figure 5 - Forward Voltage

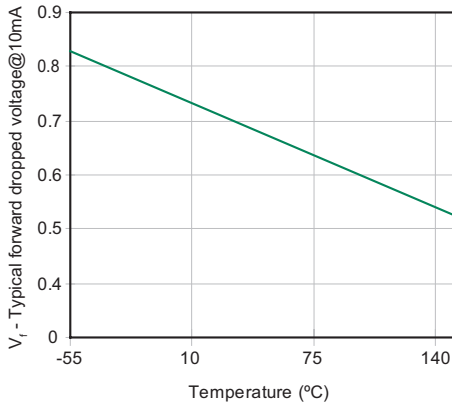

Figure 6 - Typical Junction Capacitance

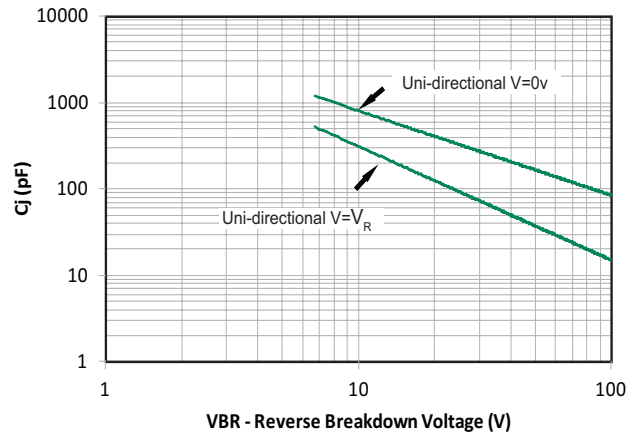

Figure 7 - Peak Forward Voltage Drop vs. Peak Forward Current

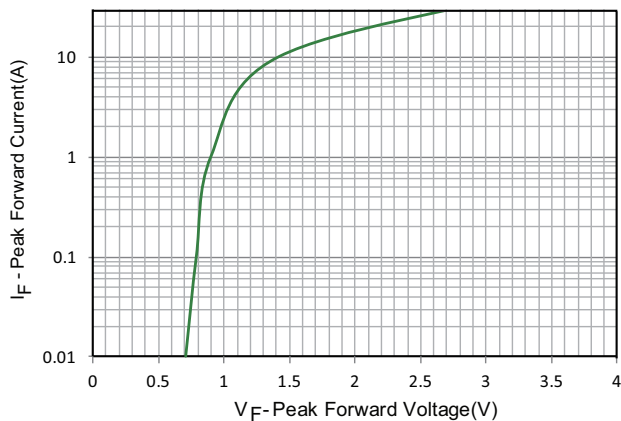

Figure 8 - Maximum Non-Repetitive Forward Surge Current Uni-Directional Only

