

VOLTAGE RANGE: 50 - 600V

CURRENT: 1.0 A

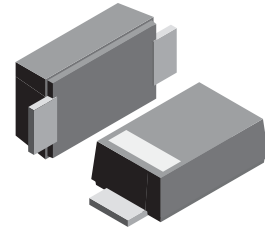

Features

- Glass Passivated Die Construction
- Ideally Suited for Automatic Assembly
- Low Forward Voltage Drop, High Efficiency
- Low Power Loss
- Super-Fast Recovery Time
- Plastic Case Material has UL Flammability Classification Rating 94V-0

Mechanical Data

- Case: SMAF, Molded Plastic
- Terminals: Solder Plated, Solderable per MIL-STD-750, Method 2026
- Polarity: Color band denotes cathode end
- Mounting Position: Any
- Weight: 0.0018 ounce, 0.064 grams

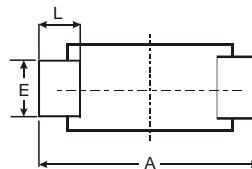
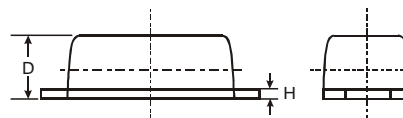
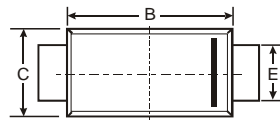

SMAF			
Dim	Min	Max	Typ
A	4.75	4.85	4.80
B	3.68	3.72	3.70
C	2.57	2.63	2.60
D	0.097	1.03	1.00
E	1.38	1.42	1.40
H	0.13	0.17	0.15
L	0.63	0.67	0.65
All Dimensions in mm			

Maximum Ratings and Electrical Characteristics T_A = 25°C unless otherwise specified

Single phase, half wave, 60Hz, resistive or inductive load. For capacitive load, derate current by 20%.

Characteristic	Symbol	ES1AF	ES1BF	ES1CF	ES1DF	ES1EF	ES1GF	ES1JF	Unit	
Peak Repetitive Reverse Voltage Working Peak Reverse Voltage DC Blocking Voltage	V _{RRM} V _{RWM} V _R	50	100	150	200	300	400	600	V	
RMS Reverse Voltage	V _{R(RMS)}	35	70	105	140	210	280	420	V	
Average Rectified Output Current @T _L = 120°C	I _O	1.0							A	
Non-Repetitive Peak Forward Surge Current 8.3ms Single half sine-wave superimposed on rated load (JEDEC Method)	I _{FSM}	30							A	
Forward Voltage @I _F = 1.0A	V _{FM}	0.95			1.25		1.7		V	
Peak Reverse Current @T _A = 25°C At Rated DC Blocking Voltage @T _A = 100°C	I _{RM}	5.0				500				μA
Reverse Recovery Time (Note 1)	t _{rr}	35								nS
Typical Junction Capacitance (Note 2)	C _j	10								pF
Typical Thermal Resistance (Note 3)	R _{θJL}	35								°C/W
Operating and Storage Temperature Range	T _j , T _{STG}	-65 to +150							°C	

- Note: 1. Measured with I_F = 0.5A, I_R = 1.0A, I_{rr} = 0.25A. See figure 5.
 2. Measured at 1.0 MHz and applied reverse voltage of 4.0 V DC.
 3. Mounted on P.C. Board with 8.0mm² land area.

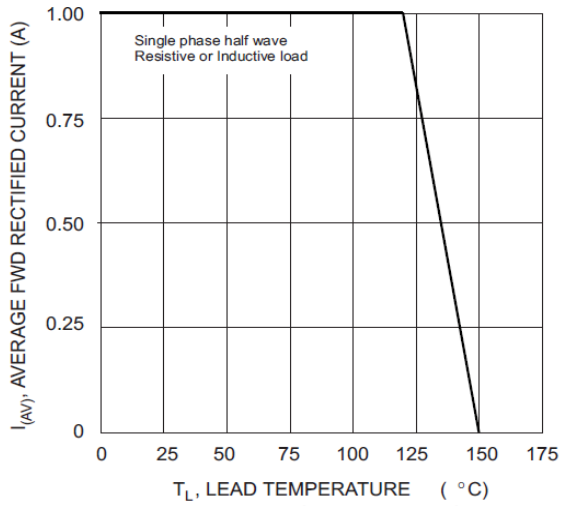

Fig. 1 Forward Current Derating Curve

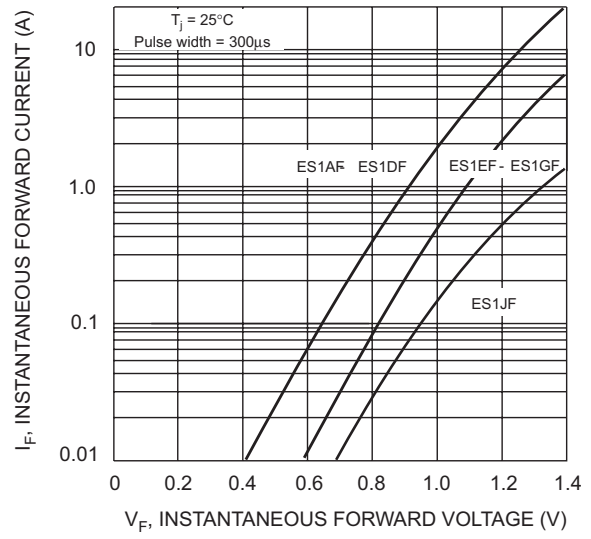

Fig. 2 Typical Forward Characteristics

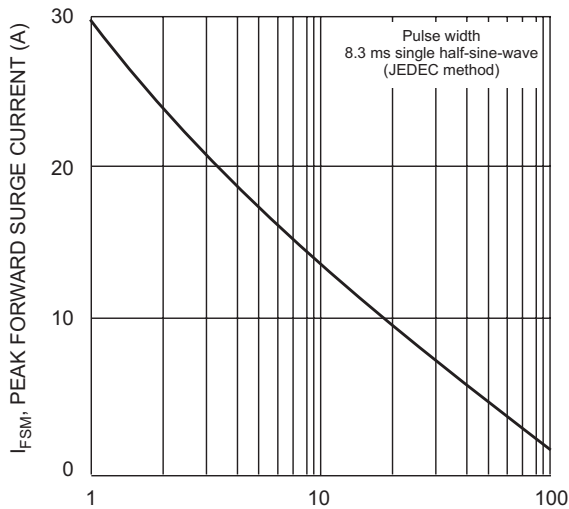

Fig. 3 Peak Forward Surge Current

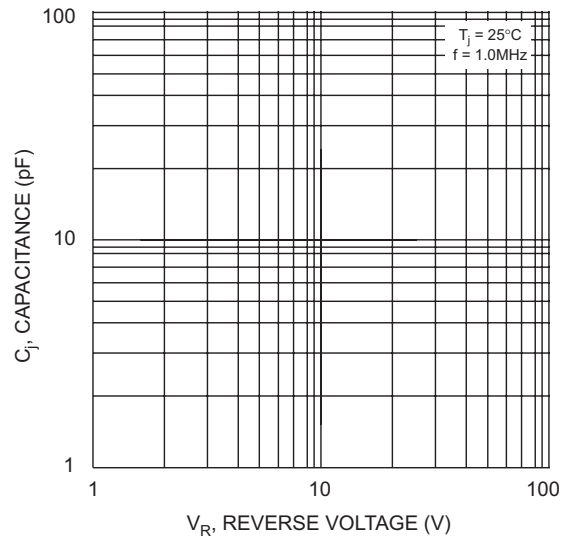
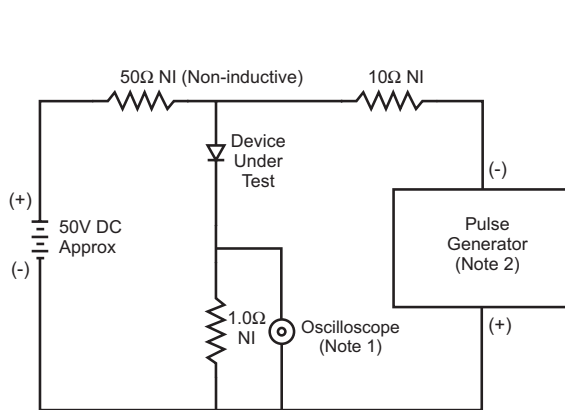
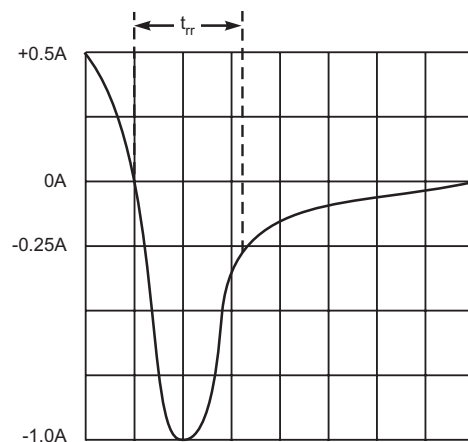

Fig. 4 Typical Junction Capacitance



- Notes:
1. Rise Time = 7.0ns max. Input Impedance = 1.0MΩ, 22pF.
 2. Rise Time = 10ns max. Input Impedance = 50Ω.



Set time base for 5/10ns/cm

Fig. 5 Reverse Recovery Time Characteristic and Test Circuit